

JNS Normal Procedure

“Consequences of unintended brake applications with LL blocks”

Final report | version 2.0 | 29.02.2024

**Outcome of the Joint Network Secretariat Task Force
“Consequences of unintended brake applications with LL
blocks”**

Part 1 : Introduction

Part 2 : Outcome

Version history:

Version	Date	Comments
0.4	20.12.2023	Available outcomes of tasks included in first draft version
0.5	12.02.2024	First complete draft version.
1.0	15.02.2024	Included comments from subgroup members
1.4	26.02.2024	Includes comments from Task Force members EIM, CER, UNIFE, NSA IT and ERA staff
2.0	29.02.2024	Final report endorsed by Task Force during TF meeting no.8, 29.02.2024 (hybrid / Brussels) for publication

Part I. Introduction

Chapter 1 : explanation JNS

Chapter 2: background and risk to be tackled

Chapter 3: organization of work

Part II. Outcome

Chapter 0: summary and orientation

Chapter 1: risk control measures

Chapter 2: changes to legislation and standards

Chapter 3: research needs and related ongoing projects

Chapter 4: impact assessment

Part I

Introduction

Content

Chapter 1 : explanation JNS

Chapter 2: background and risk to be tackled

Chapter 3: organization of work

Joint Network Secretariat (JNS)

- Triggered by accident Viareggio 2009 → Joint Sector Group at ERA
- National Safety Authorities (**NSA network**) + Representative Bodies (**NRB network**)
- Creation of **Task Forces of experts** to solve technical issues
(usually after accidents and dangerous events)
- Urgent (2 months) - and Normal Procedures (max. 2 years)
- **Every actor** can notify a JNS procedure
Form can be found at https://www.era.europa.eu/activities/joint-network-secretariat_en to be sent to jns@era.europa.eu
- **Neutral moderation and chairing** by ERA
- **From 2024¹⁾: Legal basis in CSM ASLP** (Assessment of Safety level and Safety Performance)

1) Depends on the adoption of the Regulation on these Common Safety Methods

Role of JNS procedures in the EU safety framework

- Railway Undertaking (RU) and Infrastructure Manager (IM) are together responsible for safe operation.
- In case of incidents and accidents, RUs and IMs shall evaluate, where appropriate with other involved parties (e.g. Entities in Charge of Maintenance (ECMs), keepers and loaders) if the risk requires measures immediately preventing any related danger and if yes, define and implement them.
- RUs, IMs and any other actor involved have to share relevant information (currently in Safety Alert IT (SAIT)) to allow other actors to react appropriately to ensure safety.

Role of JNS procedures in the EU safety framework

- After incidents and accidents the National Safety Authority (NSA) supervises stakeholder's immediate actions aiming at assessing whether the measures taken by the companies involved sufficiently prevent any related danger (at European level).
- If not, the NSA shall intervene respecting the responsibility of all actors. These immediate measures might increase costs for the sector and may harm interoperability
- NSAs have to share relevant information within the SIS system to allow other NSAs to react appropriately in order to ensure safety. This is usually done in the form of a **Safety Alert**

Part I, Chapter 1. : Explanation JNS

JNS in the EU safety framework

Roles of actors

7

- In parallel the National Investigation Body (NIB) may run an independent investigation of the incident or accident with the objective to find the causes and to give recommendations to the different actors involved within one year.
- In case of an incident or accident any entity (preferably the competent NSA) might notify a Joint Network Secretariat (JNS) urgent (fast track) or normal procedure by submitting a filled notification form https://www.era.europa.eu/activities/joint-network-secretariat_en to ERA (jns@era.europa.eu).

JNS urgent (fast track) procedure

- **Objective:** recommendation of appropriate European-wide harmonised short-term risk control measures in order to :
 - ensure safety,
 - Maintain or restore interoperability, and
 - reduce costs for the sector (as far as possible at this stage).
- **Result:**
 - replacement of the often costly and restrictive immediate measures of the actors and/or NSAs
- **Timeline:** Maximum 2 months

JNS Normal procedure

- **Objective:** development of mid- and long term measures, to sustainably
 - Restore / increase the safety level,
 - Ensure interoperability, and
 - Return to the previous cost base or lower.
- **Result:**
 - Identification of research needs,
 - Improvement of regulation, standardisation and other rules,
 - Update of the measures from the Urgent Procedure
- **Timeline:** Maximum 2 years

- After submission of **the notification form** to ERA, the JNS Panel needs to endorse the proposed JNS procedure.
- The **JNS panel** consists of two NSA and two RB representatives
 - Michael SCHMITZ (NSA DE)
 - Benjamin STEINBACHER-PUSNJAK (NSA SI)
 - Enno WIEBE (CER)
 - Gilles PETERHANS (UIP)
- The networks of National Safety Authorities and Representative Bodies nominate **competent experts** for the respective **JNS Task Force**
- The **Agency is moderator/facilitator and secretariat**
- ERA strives for **consensus**.

- Only nominated **Task Force members** should participate in the meetings.
- **Information shared** within the task force **remain within its members**
- **Documents are shared** on dedicated space on the Agency's Extranet.
(only accessible to nominated experts)
- The **results** (e.g. action plan, conclusions, final report) will be published in an appropriate way agreed among the task force members and have the character of a recommendation

Part I

Introduction

Content

Chapter 1 : explanation JNS

Chapter 2: background and risk to be tackled

Chapter 3: organization of work

Part I, Chapter 2. : Background and risk to be tackled

Background

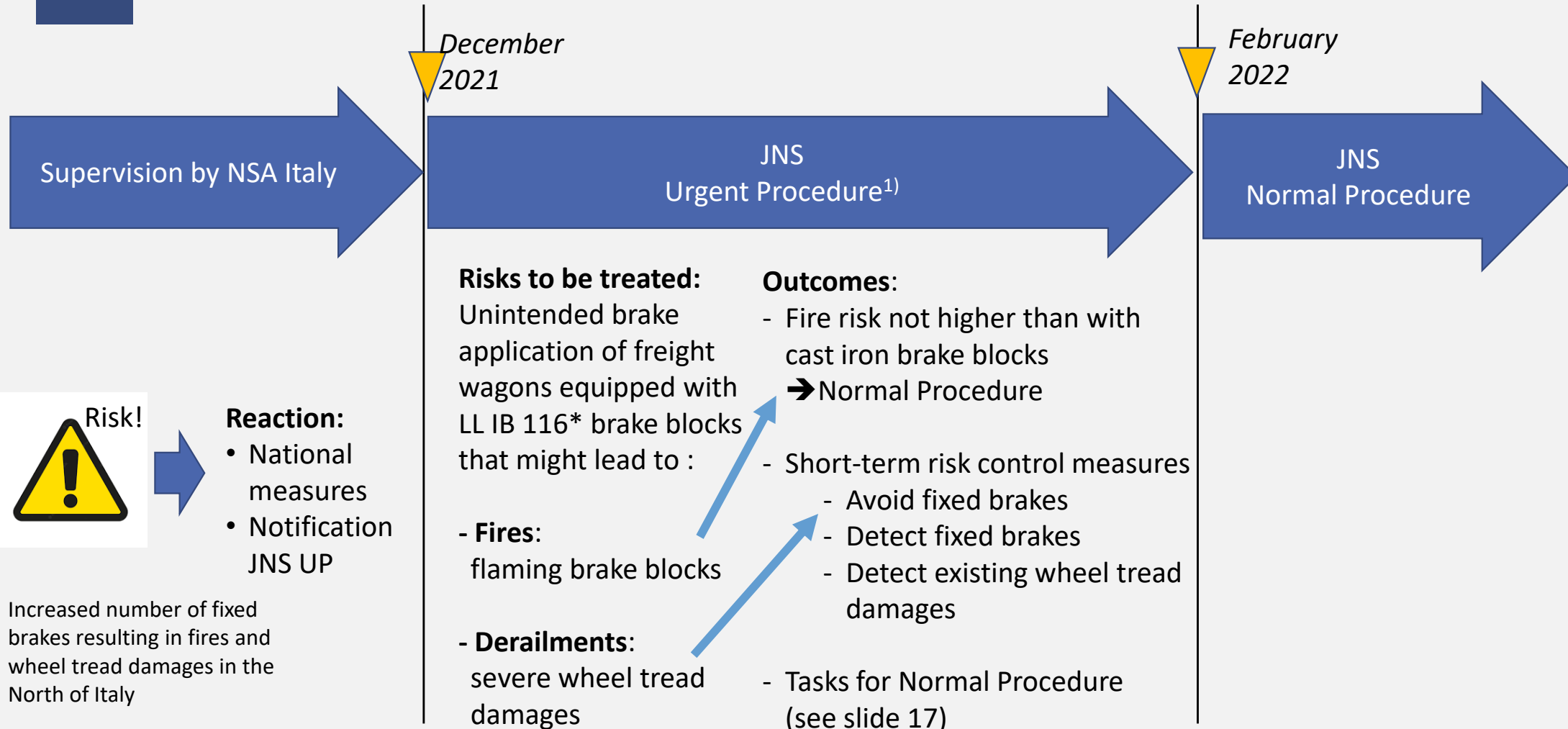

1) See report of JNS Urgent Procedure: era.europa.eu/system/files/2022-11/jns_urgent_procedure_part_2_final_v1.0.pdf

Part I, Chapter 2. : Background and risk to be tackled

Risk to be tackled in the Normal Procedure

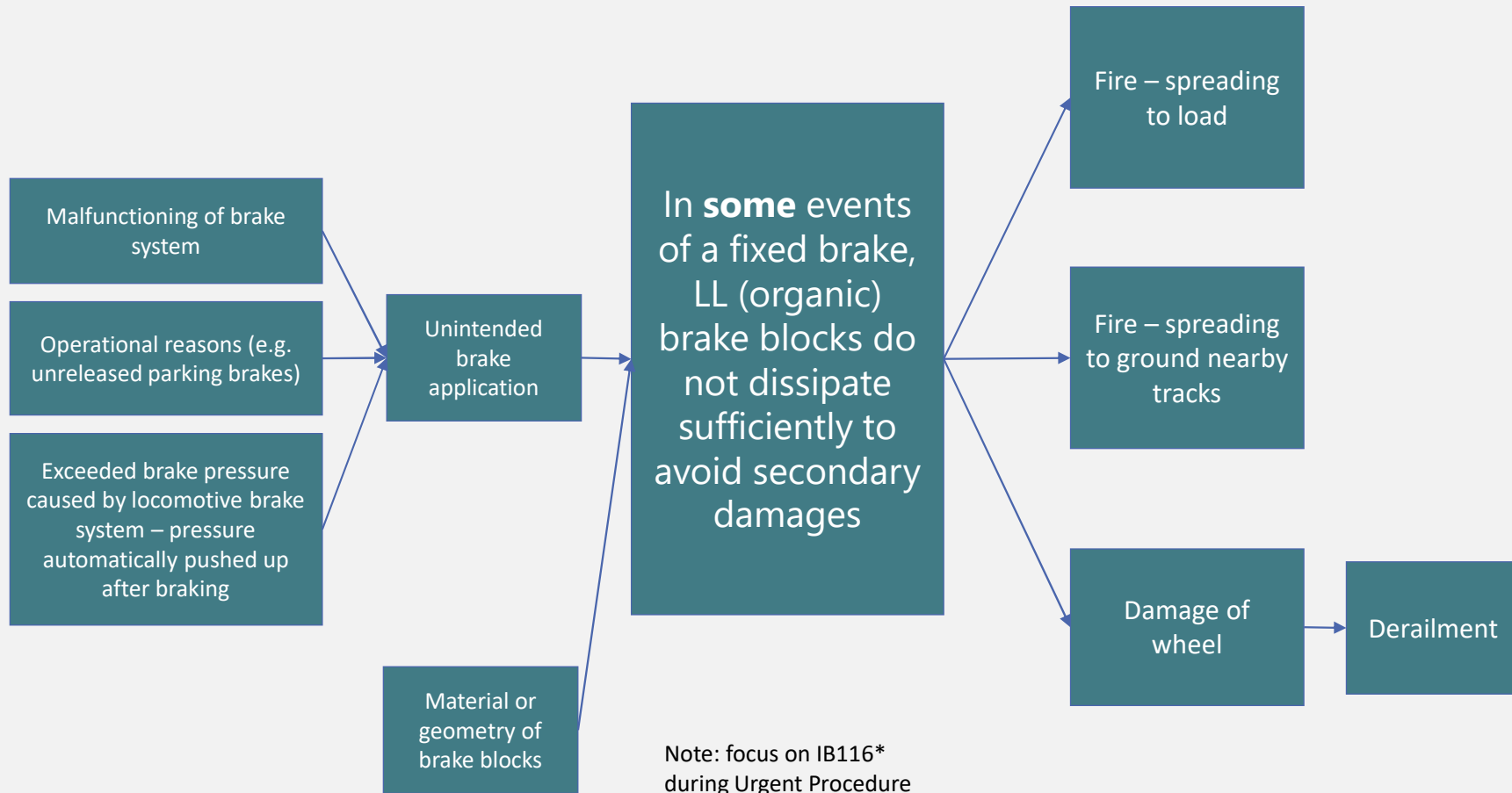

Part I

Introduction

Content

Chapter 1 : explanation JNS

Chapter 2: background and risk to be tackled

Chapter 3: organization of work

Part I, Chapter 3. : Organization of work

Overview of meetings

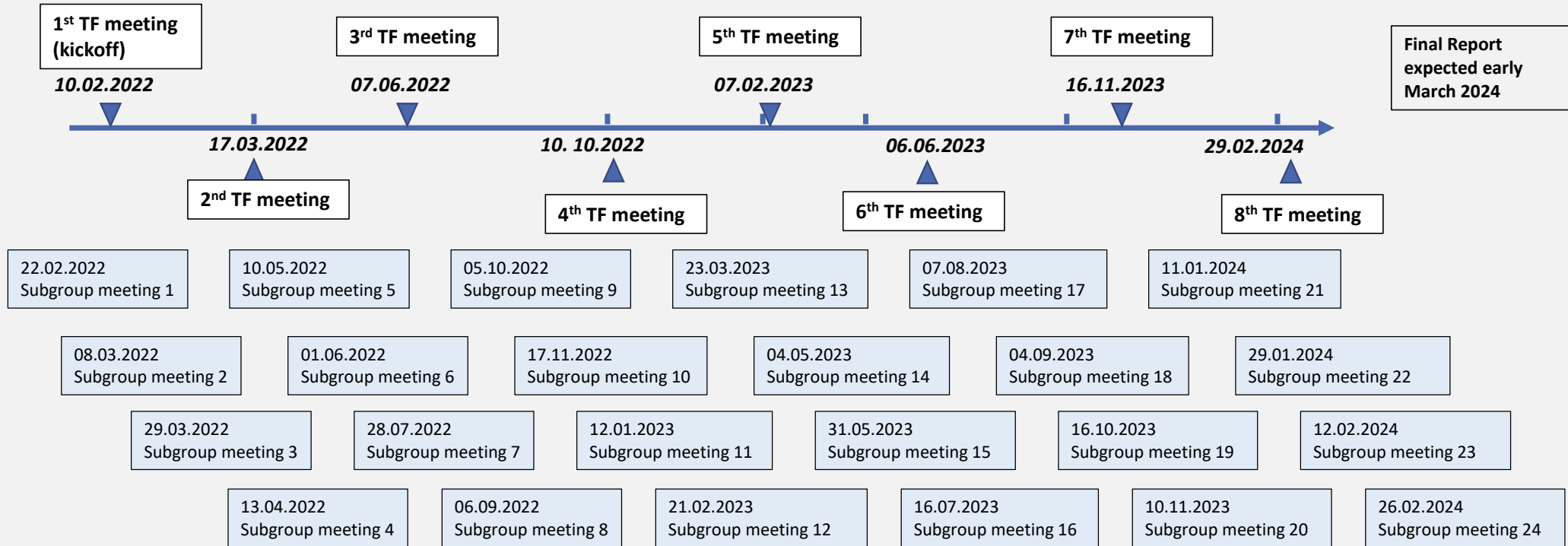

- 8 plenary Task Force meetings held, 1 further planned
- 24 subgroup meetings held
- + Further meetings on specific topics

Part I, Chapter 3. : Organization of work List of tasks for the Normal Procedure

1. Continuous collection of relevant cases from all over Europe (past and new cases).
2. Further analysis of the cases collected.
3. Review the limits and conditions of use taking into account current requirements (TSI, EN, UIC) for the application of composite brake blocks (Type LL).
4. Possible harmonization of requirements for hot axle box and hot wheel detection systems.
5. Definition of test bench tests for further analyses, under which conditions the blocks will be flamed and / or plastic deformation of the wheel tread.
6. Further fire propagation evaluation.
7. Investigate statistics of cases with regards to possible differences in quality of LL brake blocks produced in different batches/locations (link with Sector project “Brake block wheel interaction”).
8. Investigate possible solutions to improve the braking system technologies and its operations (e.g. using FTA)
9. Analysis of influence of automatic speed control and braking systems (e.g. AFB, ATO).
10. Investigate technical solutions to detect directly on the loco braking system abnormalities (e. g. hot wheels, etc.).
11. Any Other Business – updates of the GCU concerning extraordinary wheel thread deformation

Part II

Outcome

Content

Chapter 0: summary and orientation

Chapter 1: risk control measures

Chapter 2: changes to legislation and standards

Chapter 3: research needs & related non-JNS analyses

Chapter 4: impact assessment

Part II, chapter 0 : Summary and orientation

Introduction (1/4)

19

- In rail freight transport, robust and well-proven mechanical and pneumatical brake components are needed. Fixed brakes have occurred since today's air brakes have been invented more than 60 years ago and caused sparks emitted by the cast iron brake blocks and subsequent risk of fires next to the tracks or onboard the wagon.
- Fixed brakes occur independently of the type of brake blocks. However, when the LL composite brake blocks were introduced all over the EU in the early 2010's, the consequences differed from fixed cast iron brake blocks:
 - Flaming brake blocks (with less high-energetic sparks);
 - An increased probability of the occurrence of extraordinary wheel tread deformation.
- Complete prevention of fixed brakes is economically not feasible.
- The increase of the number of fixed brakes resulting in fires and wheel tread damages in the North of Italy at the end of 2021 has led to a JNS Urgent Procedure. This Normal Procedure is its follow-up and covers the activities describes on the next slides.



- Analysis of relevant cases of fixed LL composite brake blocks collected in the JNS Normal Procedure has shown that they have been caused by an unfavorable use (see slides nr. 26 to 30). Furthermore, a Fault Tree Analysis has been carried out to identify all possible causes of fixed brakes and how they are currently controlled.
- As a result, a list of risk control measures has been developed . This list contains measures to..
 - .. reduce the number of fixed brakes;
 - .. detect fixed brakes;
 - .. check wheels for extraordinary tread wear / deformation.

A number of measures refer to existing best practices that have not yet been well documented.

- **These risk control measures replace entirely the measures from the JNS Urgent Procedure¹⁾**
- In order to better control the risk of fixed LL composite brake blocks, it is recommended that the safety managers of the actors concerned, namely ...

Railway undertakings (RU); Infrastructure Managers (IM); Entities in Charge of Maintenance of freight wagons/locomotives (ECM); Manufacturers of freight wagons/locomotives; Loaders/terminals

ensure that these risk control measures are either implemented or, in case of alternative measures, at least the same level of safety is assured, respecting the provisions and responsibilities set out in Article 4 of the Railway Safety Directive (see slides 23 – 25).

1) See report of JNS Urgent Procedure: era.europa.eu/system/files/2022-11/jns_urgent_procedure_part_2_final_v1.0.pdf

- In addition, the need for changes in legislation and/or standards was examined. In this respect, the requirements for the design of brake blocks, fire safety, trackside detection systems and brake air quality have been analysed with the following conclusions:
 - The requirements for the design of LL composite brake blocks are sufficiently covered in the current legal framework (Interoperability Directive, including the WAG TSI and the CSM on REA, the EN standard) and related UIC documents. However, the future WAG TSI should refer to only the EN16452 standard, which requires alignment with the UIC leaflet 541-4 and integration of the technical document ERA/TD/2013-02/INT. (see Part II, section 2.1);
 - Requirements for spark arresters are missing in the WAG TSI (see Part II, section 2.2). A respective proposal for a change request has been formulated;
 - There are no requirements for hot wheel detection systems in the INF TSI and the EN 15437-1 standard. In addition, there are no requirements on the use of these detection systems in the OPE TSI. Proposals for changes have been formulated. (see Part II, section 2.3);
 - Regarding the air quality, railway-specific harmonized requirements are missing. The Task Force formulated a proposal for a standardization request. (see Part II, section 2.4).

- Finally, the JNS Task Force looked for research needs and related ongoing projects. The focus was put on the block and wheel behavior in a fixed brake situation, possible differences of brake block properties caused by deviations in the manufacturing process and on rolling-stock side detection systems
 - The development of the coefficient of friction of brake blocks involved in a fixed brake was analyzed in order to determine if such brake blocks present an additional risk after the fixed brake event – this was not the case;
 - The influence from the wheel-track contact force and the conditions under which a fixed brake can lead to extraordinary wheel tread deformation are further investigated in the sector project “brake block-wheel interaction”;
 - The possibility that the deviations in the manufacturing process of composite LL brake blocks cause unwanted consequences of fixed brakes is investigated in the sector project “brake block-wheel interaction”;
 - A first inventory was made of rolling stock-side detection systems with the potential to detect fixed brakes. At this stage, only test systems exist. The implementation needs further development and can not replace the trackside detection systems on short or medium term.
- The JNS Task Force did not identify further research needs and recommends to observe these developments and to start a review of the JNS Normal Procedure outcome based on the results of this work (see Part II, Chapter 3).

Part II, chapter 0 : Summary and orientation

Railway Safety Directive (EU) 2016/798 – Article 4

1. *With the aim of developing and improving railway safety, Member States, within the limits of their competences, shall:*
 - (d) *ensure that the responsibility for the safe operation of the Union rail system and the control of risks associated with it is laid upon the infrastructure managers and railway undertakings, each for its part of the system, obliging them to:*
 - (i) implement necessary risk control measures as referred to in point (a) of Article 6(1), where appropriate in cooperation with each other;
 - (ii) apply Union and national rules;
 - (iii) establish safety management systems in accordance with this Directive;
 - (e) *without prejudice to civil liability in accordance with the legal requirements of the Member States, ensure that each infrastructure manager and each railway undertaking is made responsible for its part of the system and its safe operation, including supply of materials and contracting of services vis-à-vis users, customers, the workers concerned and other actors referred to in paragraph 4;*

permanent
application of process
based on CSM REA

Part II, chapter 0 : Summary and orientation

Railway Safety Directive (EU) 2016/798 – Article 4

3. *Railway undertakings and infrastructure managers shall:*

- (a) *implement the necessary **risk control measures** referred to in point (a) of Article 6(1), where appropriate in cooperation with each other and with other actors;* permanent process based on CSM REA
- (b) *take account in their **safety management systems** of the risks associated with the activities of other actors and third parties;*
- (c) *where appropriate, **contractually oblige the other actors** referred to in paragraph 4 having a potential impact on the safe operation of the Union rail system to implement risk control measures; and* ECMs, terminals, ...
- (d) *ensure that their contractors implement risk control measures through the **application of the CSMs for monitoring** processes set out in the CSMs on monitoring referred to in point (c) of Article 6(1), and that this is stipulated in contractual arrangements to be disclosed on request of the Agency or of the national safety authority.*

Part II, chapter 0 : Summary and orientation

Railway Safety Directive (EU) 2016/798 – Article 4

5. *Railway undertakings, infrastructure managers and any actor referred to in paragraph 4 who identifies or is informed of a safety risk relating to defects and construction non-conformities or malfunctions of technical equipment, including those of structural subsystems, shall, within the limits of their respective competence:*
- (a) take any necessary corrective measure to tackle the safety risk identified;*
- (b) report those risks to the relevant parties involved, in order to enable them to take any necessary further corrective action to ensure continuous achievement of the safety performance of the Union rail system. The Agency may establish a tool that facilitates this exchange of information among the relevant actors, taking into account the privacy of the users involved, the results of a cost-benefit analysis as well as the IT applications and registers already set up by the Agency.*
- ECMs, terminals, ...*

Part II, chapter 0 : Summary and orientation

Analysis of cases collected during the Normal Procedure

Overview of collected cases

- A total of 19 cases were reported in a period of 24 months
- Information was collected according to an agreed template (can be found [here](#)) and using a dedicated emailaddress²⁾
- 15 incidents were categorized as “relevant”
- The detailed data on the incidents is summarized in the consolidated data collection table:
[consolidated data table](#)¹⁾
- The documents and photos submitted for each case can be found here:
[thermal overload – incidents](#)¹⁾
- 6 cases with extraordinary wheel tread deformation and fire
- 5 cases with fire only
- 4 cases with extraordinary wheel tread deformation only

1) Information is not published and restricted to the JNS Task Force

2) After the closure of the Normal Procedure, the collection and analysis of cases will stop

Part II, chapter 0 : Summary and orientation

Analysis of cases collected during the Normal Procedure

Root causes

- In 5 incidents, no information was provided on the cause
- In 2 incidents, a non-released handbrake was cited as the cause
- In 3 incidents, an overloaded distributor valve was suspected as the cause, which could not be clearly determined afterwards
- In 2 incidents, unconditional release times were suspected
- In 1 incident, a blocked brake rigging was listed as the cause
- In 1 incident, general operational reasons were given

Based on the 19 cases collected, the following observations can be made:

- No correlation to certain types of freight wagons;
- No correlation to certain types of locomotives;
- No correlation to the position of the wagon in the train;
- Cases occurred all over Europe;
- No correlation to the season;
- All incidents occurred with trains driving at a maximum speed of 100 km/h;
- Cases occurred both on level tracks and on tracks with slopes and gradients. No correlation to the topography;

Part II, chapter 0 : Summary and orientation

Analysis of cases collected during the Normal Procedure

Main observations (2/3)

- Cases occurred with trains operated both manually and operated with automatic speed control and braking systems;
- In the vast majority of cases, data from data recorder unavailable;
- Reaction time of the brake has no influence: all kind of brake position (P, long locomotive and G) are involved;
- When full brake tests on the fixed braked freight wagons were performed, mostly no errors were found;
- Some cases occurred after a change of locomotive (e.g. at the borders);
- Main information about the outcome of track side detection systems mostly not provided / available;
- The data provided by the IMs and the RUs on the cases was not always complete to identify the root cause of the fixed brake event;

Part II, chapter 0 : Summary and orientation

Analysis of cases collected during the Normal Procedure

Main observations (3/3)

- Due to the technical, economical and organizational context in which the IMs and RUs operate, it is not possible to entirely prevent and detect fixed brakes.
- ➔ The Task Force collected the best practices of measures
 - .. to reduce the number of fixed brakes (Part II, section 1.1);
 - .. to detect fixed brakes (Part II, section 1.2);
 - .. to check wheels for extraordinary tread wear / deformation (Part II, section 1.3).

Part II

Outcome

Content

Chapter 0: summary and orientation

Chapter 1: risk control measures

Chapter 2: changes to legislation and standards

Chapter 3: research needs & related non-JNS analyses

Chapter 4: impact assessment

Part II, Chapter 1

Risk control measures

Content

Part II, section 1.1: Measures to reduce the number of fixed brakes

Part II, section 1.2: Measures to detect fixed brakes

Part II, section 1.3: Measures to check wheels for extraordinary tread wear / deformation

Part II, Chapter 1. : Risk Control Measures overview

33

	Risk Control Measures		
	...to reduce the number of fixed brakes	...to detect fixed brakes	...to check the wheels for extraordinary tread wear / deformation
RU	Slides 34 – 40	Slides 53 - 58	Slides 60 – 61
ECM (wagon)	Slides 41 – 44	--	Slides 60 - 61
ECM (locomotive)	Slide 45	--	--
Manufacturer (wagon)	Slides 46 – 47	--	--
Manufacturer (locomotive)	Slide 48	--	--
Loader/terminal	Slide 49	--	--
IM	Slide 50	Slide 53 - 55	--
Workshop	Slide 51	--	--

All actors are recommended to implement these risk control measures which replace entirely the risk control measures identified in the Urgent Procedure. For every measure, it is indicated which measure of the Urgent Procedure it replaces (if any) – see footnotes. Please note that measures 2.1.5 of the Urgent Procedure is not replaced by any measure of the Normal Procedure.

Part II, Chapter 1: Risk Control Measures

Section 1.1: Measures to reduce the number of fixed brakes

Railway undertakings (RU)

Measure	When to apply	Reason
Ensure appropriate application of the assimilation function : <ul style="list-style-type: none"> - Complete application of the assimilation function before applying the brake, unless operational conditions require otherwise - Use assimilation with overcharge memory function (EN 14198) if available 	Before departure: <i>replaces measure 2.1.1¹⁾</i> <ul style="list-style-type: none"> - In case of a change of a locomotive, including change of locomotive from one side of the train to the other; - After use of stationary devices, <i>new¹⁾</i> - During performing the simplified brake test <i>new¹⁾</i> 	When not applying appropriately the assimilation function, reduced pressure in the brake pipe along the train might occur which could lead to an overloaded control chamber.
	Train stand still for many hours; it has the brakes applied in cold climate and the sun heats up the A-chamber (or the ambient temperature rises quickly). <i>new¹⁾</i>	The brakes will not release because the pressure is increased in the A-chamber (volume dilatation and increasing pressure).
	During train run: manual assimilation shall be used, if overcharge automatic function not available. <i>new¹⁾</i>	If the locomotive is not equipped with an automatic assimilation function, the correct use of the manual assimilation function is essential.

1) Comparison to risk control measures identified in the JNS Urgent Procedure: era.europa.eu/system/files/2022-11/jns_urgent_procedure_part_2_final_v1.0.pdf

Part II, Chapter 1: Risk Control Measures

Section 1.1: Measures to reduce the number of fixed brakes

Railway undertakings (RU)

Measure	When to apply	Reason
Ensure appropriate use and quantity of anti freezing liquid that still allow brake system to function	In case of necessity <i>new¹⁾</i>	If using too much anti freezing liquid, liquid can block the airpipe or get into the distributors. This creates the risk that the distributors do not get the signal to release the brakes.
Communication and application of a brake test after change of the locomotive.	In case of driving using a higher brake pressure (e.g. when using a locomotive in the degraded state back up mode of the brake pipe pressure control system) <i>new¹⁾</i>	In case of driving a locomotive in degraded state back up mode of the brake pipe pressure control system with higher brake pipe normal working pressure (e. g. 5,4 bar), and after a change of locomotive, there is a risk of not releasing brakes due to limited max. overcharge pressure.
Ensure staff switches off only the malfunctioning brake system in the wagons with more than one brake system	In case wagons are equipped with more than 1 distributor valve and one or more malfunctioning brake systems <i>new¹⁾</i>	If a wagon or unit is equipped with more than one brake system and one or more brake system malfunction is detected, there is a risk that accidentally the non-faulty brake will be switched off

1) Comparison to risk control measures identified in the JNS Urgent Procedure: era.europa.eu/system/files/2022-11/jns_urgent_procedure_part_2_final_v1.0.pdf

Part II, Chapter 1: Risk Control Measures

Section 1.1: Measures to reduce the number of fixed brakes

Railway undertakings (RU)

Measure	When to apply	Reason
Ensure staff uses correctly the switch-off function of the brake system taking into account the properties of the components	Planning the trainings for the railway undertaking staff <i>new¹⁾</i>	Different behavior of distributors after switching off the brake: <ul style="list-style-type: none"> - KE brakes release; - Dako, Charmilles, Oerlikon, Westinghouse brakes apply: If you do not use the release bar for Charmilles, Oerlikon, Dako and Westinghouse you have an unreleased / fixed brake.
		Different behavior if not applying the release bar: <p>If you don't use the release bar you are not able to release the distributor valve.</p>
Ensure staff knows how to use handbrakes that are controlled by more than just the handbrake wheel	Planning the trainings for the railway undertaking staff <i>new¹⁾</i>	If the handbrake is not correctly used, this may result in a fixed brake.
Keep documentation which wagons are braked with handbrake / stop block (scotch)	Before departure simplified brake test: applying handbrake <i>new¹⁾</i>	When parking a train, it must be clearly documented / marked on which wagon the handbrake was applied, otherwise the applied brake will not be recognized on these wagons during the simplified brake test.

1) Comparison to risk control measures identified in the JNS Urgent Procedure: era.europa.eu/system/files/2022-11/jns_urgent_procedure_part_2_final_v1.0.pdf

Part II, Chapter 1: Risk Control Measures

Section 1.1: Measures to reduce the number of fixed brakes

Railway undertakings (RU)

Measure	When to apply	Reason
Ensure staff treats all brake systems of a wagon as a separate brake system	Before departure: operating the brake e. g. isolating, pulling release bar <i>new¹⁾</i>	In case of wagons existing with more than 1 distributors, the train staff could wrongly operate the brake systems as a unique brake system causing, e.g. a wrong isolating or pulling release bar.
Equip staff with tools that allow them to check the functioning of the brakes, taking into account their visibilities (e. g. telescope stick)	Before departure, when carrying out a full or simplified brake test, in cases of limited visibility of the brake system <i>new¹⁾</i>	With certain wagon designs, the status of the brake and / or handbrake cannot be clearly identified and can lead to not identified fixed brakes.
Ensure that staff correctly applies the classical (not automated) quick release function (filling stroke)	The filling stroke must be ended before distributor valves are in released position – the time limit for using the filling stroke depends on the train length. <i>new¹⁾</i>	<p>Using the filling stroke after the distributor valves are in released position may lead to overloaded A-chambers and subsequently to a fixed brakes</p> <p>The classical (not automated) high pressure quick release function is sensitive regarding the conditions of use (e. g. length of the train, brake position ...) and can therefore lead to wrong application by the train driver.</p> <p>In newer locomotives (produced from 2008 onwards) this function is therefore usually blocked.</p>

1) Comparison to risk control measures identified in the JNS Urgent Procedure: era.europa.eu/system/files/2022-11/jns_urgent_procedure_part_2_final_v1.0.pdf

Part II, Chapter 1: Risk Control Measures

Section 1.1: Measures to reduce the number of fixed brakes

Railway undertakings (RU)

Measure	When to apply	Reason
Ensure that the train drivers use appropriately the quick release function	Planning the trainings for the staff and during train operation <i>replaces measure 2.1.4¹⁾</i>	Locomotives are equipped with different quick release systems. These are operated differently according to the assimilation / overcharging function
Ensure that the train drivers know and consider the individual release times of the train composition they are driving	Planning the trainings for the staff for train operation <i>new¹⁾</i>	Each individual train has different release times influenced by train length, brake mode, type of loco, type of wagons. If the train driver accelerates too early, parts of the train will still be braked.
The automatic traction and braking system should only be used when the dynamic brake is sufficient to control the train speed	Not during train run on lines with continuous gradients (e. g. on lines where the “saw tooth” algorithm is used) <i>new¹⁾</i>	coordination / cooperation between automatic traction and braking system and wagon braking system can be suboptimal, in particular on lines with continuous gradients (see also JNS Task 9). (ETCS can change the permitted speed and so the train driver is not able to react on this situation (e. g. electrical brake system is for the new speed not sufficient)

1) Comparison to risk control measures identified in the JNS Urgent Procedure: era.europa.eu/system/files/2022-11/jns_urgent_procedure_part_2_final_v1.0.pdf

Part II, Chapter 1: Risk Control Measures

Section 1.1: Measures to reduce the number of fixed brakes

Railway undertakings (RU)

Measure	When to apply	Reason
<p>The start-up test shall be carried out as follows:</p> <ul style="list-style-type: none"> · If the traction unit is operated from the driver's cab, at least one window in the driver's cab shall be opened. · The train shall be set in motion with the lowest possible traction force. · When the train is in motion and has reached walking speed, the traction force shall be switched off. <p><i>Start-up test continues on next slide</i></p>	<p>On the first start-up of a regular freight train after train composition, parking, locomotive change or emergency brake intervention (and when the train driver knows the gradient of the line) a start-up test shall be carried out.</p> <p>When all conditions for the departure of the train have been met, the start-up test may begin.</p> <p>The track and signal observation shall not be affected by the following activities.</p> <p><i>replaces measures 2.1.2 and 2.1.3¹⁾</i></p>	<p>During the processes of</p> <ul style="list-style-type: none"> - Composing a train; - Parking a train; - Changing a locomotive; - Emergency brake intervention. <p>one or more fixed brakes may be triggered and overlooked during the pre-departure checks.</p>

1) Comparison to risk control measures identified in the JNS Urgent Procedure: era.europa.eu/system/files/2022-11/jns_urgent_procedure_part_2_final_v1.0.pdf

Part II, Chapter 1: Risk Control Measures

Section 1.1: Measures to reduce the number of fixed brakes

Railway undertakings (RU)

Measure	When to apply	Reason
<p>The train shall be stopped immediately if any irregularities are detected, and the cause shall be investigated. Characteristics of irregularities may be:</p> <ul style="list-style-type: none"> · significant reduction in speed (braking effects) · unusual jerking or tugging · grinding noises · no run-up of the wagons towards the loco <p>a) If no irregularities are detected, the train may continue its journey.</p> <p>b) If irregularities are detected, the start-up test shall be end and only be repeated after the train has been fully checked for forgotten drag shoe, handbrakes or unreleased brakes. → Repeat the start up test</p>	<p>On the first start-up of a regular freight train after train composition, parking, locomotive change or emergency brake (when the train driver knows the gradient of the line) intervention a start-up test shall be carried out.</p> <p>When all conditions for the departure of the train have been met, the start-up test may begin.</p> <p>The track and signal observation shall not be affected by the following activities.</p> <p><i>replaces measures 2.1.2 and 2.1.3¹⁾</i></p>	<p>During the processes of</p> <ul style="list-style-type: none"> - Composing a train; - Parking a train; - Changing a locomotive; - Emergency brake intervention. <p>one or more fixed brakes may be triggered and overlooked during the pre-departure checks.</p>

1) Comparison to risk control measures identified in the JNS Urgent Procedure: era.europa.eu/system/files/2022-11/jns_urgent_procedure_part_2_final_v1.0.pdf

Part II, Chapter 1: Risk Control Measures

Section 1.1: Measures to reduce the number of fixed brakes

Entity in charge of maintenance (ECM) – freight wagon

Measure	When to apply	Reason
ECM shall provide information/instructions, directly or via the keeper, for the RU to ensure its staff uses correctly the brake components from different manufacturers.	Before the takeover of wagon by the railway undertaking <i>new¹⁾</i>	Distributors behave differently after switching off the brake.: - KE brake releases; - Dako, Charmilles, Oerlikon, Westinghouse brakes apply: If you do not use the release bar for Charmilles, Oerlikon, Dako and Westinghouse you have an unreleased / fixed brake
		Different behavior applying the release bar: If you don't use correctly the release bar you are not able to release the distributor valve
Replace “old” distributor valves	In case of distributor valves from before 1982, which do not fulfil the requirements for protection against quick release function <i>new¹⁾</i>	Risk of overloading the distributor valves (A-chamber) when the train driver applies the quick release function

1) Comparison to risk control measures identified in the JNS Urgent Procedure: era.europa.eu/system/files/2022-11/jns_urgent_procedure_part_2_final_v1.0.pdf

Part II, Chapter 1: Risk Control Measures

Section 1.1: Measures to reduce the number of fixed brakes

Entity in charge of maintenance (ECM) – freight wagon

Measure	When to apply	Reason
<p>Consider actual operational conditions (e.g. environmental conditions and transport performance) in maintenance plan (scope and interval) for in particular following components:</p> <ul style="list-style-type: none"> - distributor valves; - relay valves; - slack adjustors. 	<p>When drafting and periodically reviewing the maintenance plan</p> <p><i>new¹⁾</i></p>	<p>If the maintenance plan does not sufficiently consider the actual operational conditions, the risk of spontaneous defects increases.</p>
<p>Drain the settling (sedimentation) chambers in appropriate intervals</p>	<p>When drafting and periodically reviewing the maintenance plan of the settling (sedimentation) chambers</p> <p><i>new¹⁾</i></p>	<p>Frost in combination with humidity could lead to malfunctions.</p>
<p>Consider the correct air quality (a harmonized air class quality to be used in maintenance is missing in the existing normative references)</p>	<p>When drafting and periodically reviewing the maintenance plan</p> <p><i>new¹⁾</i></p>	<p>The air quality supplied by locomotives, stationary devices and in the maintenance affect the long-term functioning of the air brake system</p>

1) Comparison to risk control measures identified in the JNS Urgent Procedure: era.europa.eu/system/files/2022-11/jns_urgent_procedure_part_2_final_v1.0.pdf

Part II, Chapter 1: Risk Control Measures

Section 1.1: Measures to reduce the number of fixed brakes

Entity in charge of maintenance (ECM) – freight wagon

Measure	When to apply	Reason
Mark correctly the wagons in accordance with EN 15877	In case a freight wagons is equipped with more than 1 distributor valve <i>new¹⁾</i>	If a wagon is not or incorrectly marked, the wagon may not be operated in accordance with the operational rules as set out in the RU's Safety Management System (e. g. operation of all quick release bars).
Grease appropriately the brake rigging taking into account sufficiently the actual operational conditions (e.g. environmental conditions and transport performance)	When drafting and periodically reviewing the maintenance plan <i>new¹⁾</i>	If the rigging is not sufficiently greased, a fixed brake due to a blocked rigging can occur.
Ensure the correct piston stroke	When drafting and periodically reviewing the maintenance plan <i>new¹⁾</i>	An incorrect piston stroke can cause the brake rigging to jam.

1) Comparison to risk control measures identified in the JNS Urgent Procedure: era.europa.eu/system/files/2022-11/jns_urgent_procedure_part_2_final_v1.0.pdf

Part II, Chapter 1: Risk Control Measures

Section 1.1: Measures to reduce the number of fixed brakes

Entity in charge of maintenance (ECM) – freight wagon

Measure	When to apply	Reason
Ensure sufficient air tightness of the brake system	When drafting and periodically reviewing the maintenance plan <i>new¹⁾</i>	If the accumulation of leaks in the brake pipe of the individual wagon exceeds the insensitivity gradient of the distributor valve, there is a fixed brake
Installation of indicators on the wagon to show the status of the parking brake (possible solution for new build wagons)	During maintenance at the workshop. <i>new¹⁾</i>	Without clear identification, an unreleased handbrake might not be detected during normal and simplified brake tests.
Ensure that sufficient information on how to use the handbrakes is made available to the railway undertaking, either directly or via the keeper.	In case the wagon is equipped with an uncommon (handbrake that is controlled by more than just the handbrake wheel) <i>new¹⁾</i>	If the handbrake is not correctly used, this may result in a fixed brake.

1) Comparison to risk control measures identified in the JNS Urgent Procedure: era.europa.eu/system/files/2022-11/jns_urgent_procedure_part_2_final_v1.0.pdf

Part II, Chapter 1: Risk Control Measures

Section 1.1: Measures to reduce the number of fixed brakes

Entity in charge of maintenance (ECM) – locomotive

Measure	When to apply	Reason
Ensure the availability of the assimilation function with memory function in accordance with EN 14198 on all locomotives	After the classification of the change according to Regulation 2018/545 Article 15(1), upgrading the locomotive in a workshop certified for the affected change <i>new¹⁾</i>	The overcharge memory function allows the automatization of the assimilation process, thereby avoiding consequences not applying appropriately the assimilation function (reduced pressure in the brake pipe along the train might occur which could lead to an overloaded control chamber).
Consider actual operational conditions (e.g. environmental conditions and transport performance) in maintenance plan (scope and interval)	When drafting and periodically reviewing the maintenance plan <i>new¹⁾</i>	If the maintenance plan does not sufficiently consider the actual operational conditions, the risk of spontaneous defects increases.
Supply the correct air quality (a harmonized air class quality to be used in maintenance is missing in the existing normative references)	Provide traction for train run <i>new¹⁾</i>	If air quality is below recommended quality, long-term performance is not guaranteed.
Ensure appropriate use and quantity of anti freezing liquid that still allow brake system to function	During preventive maintenance (in case of necessity) <i>new¹⁾</i>	If using too much anti freezing liquid, liquid can block the airpipe or get into the distributors. This creates the risk that the distributors do not get the signal to release the brakes.

1) Comparison to risk control measures identified in the JNS Urgent Procedure: era.europa.eu/system/files/2022-11/jns_urgent_procedure_part_2_final_v1.0.pdf

Part II, Chapter 1: Risk Control Measures

Section 1.1: Measures to reduce the number of fixed brakes

Manufacturer freight wagon

Measure	When to apply	Reason
Ensure that new freight wagons are equipped with air pipes which do not contain water traps. (.e.g. by complying with EN 14198 concerning the layout of the brake pipe)	During the design phase of the wagon <i>new¹⁾</i>	If, under winter conditions, the freezing of the condensed water that is collected in water traps, might congest the brake pipes and cause malfunctioning of the brake.
Ensure that new freight wagons are equipped with (hand)brake systems which functions can reliably be checked by either: <ul style="list-style-type: none"> - staff in the field (good visibility required) - alternative methods 	During the design phase of the wagon <i>new¹⁾</i>	With some of today's wagons' designs, the status of the brake and / or handbrake cannot be clearly identified and can lead to not identified fixed brakes.
Ensure that new freight wagons are equipped with indicators on the wagon that show the status of the handbrake	During the design phase of the wagon <i>new¹⁾</i>	Without clear identification, an unreleased handbrake might not be detected during normal and simplified brake tests.

1) Comparison to risk control measures identified in the JNS Urgent Procedure: era.europa.eu/system/files/2022-11/jns_urgent_procedure_part_2_final_v1.0.pdf

Part II, Chapter 1: Risk Control Measures

Section 1.1: Measures to reduce the number of fixed brakes

Manufacturer freight wagon

Measure	When to apply	Reason
Equip new freight wagons with handbrakes that are controlled only by the handbrake wheel	During the design phase of the wagon <i>new¹⁾</i>	Handbrakes that are controlled not (only) by a handbrake wheel increase the probability of human error.
Design new freight wagons in order to protect the air brake system	During the design phase of the wagon – after consultation with the distributor valve manufacturer <i>new¹⁾</i>	Inserting a filter in the wagon before the distributor valve could protect the distributor valve and the overall air brake system .

1) Comparison to risk control measures identified in the JNS Urgent Procedure: era.europa.eu/system/files/2022-11/jns_urgent_procedure_part_2_final_v1.0.pdf

Part II, Chapter 1: Risk Control Measures

Section 1.1: Measures to reduce the number of fixed brakes

Manufacturer locomotive

Measure	When to apply	Reason
Equip new locomotives with the assimilation function with overcharge memory function in accordance with EN 14198	During the design phase of the locomotive <i>new¹⁾</i>	The overcharge memory function allows the automatization of the assimilation process, thereby avoiding consequences not applying appropriately the assimilation function (reduced pressure in the brake pipe along the train might occur which could lead to an overloaded control chamber).
Ensure that new locomotives are equipped with the automated quick release function	During the design phase of the locomotive <i>new¹⁾</i>	The automated quick release function prevents the distribution valves from being overcharged.
Supply the correct air quality (see EN14198)	Design of the locomotive <i>new¹⁾</i>	If air quality is below recommended quality, long-term performance is not guaranteed.
Equip new freight locomotives with a function implementing the «start-up test» and disabling the automatic traction and braking system.	During the design phase of the locomotive <i>new¹⁾</i>	Limit human factors in the application of the recommendations to reduce the number of fixed brakes. When the «zero-speed» condition is met, the automatic traction and braking system shall be disabled until a braking force is applied by the train driver. The train driver shall be able to manually override the new «function» if necessary (e.g. uphill starts, etc.)

1) Comparison to risk control measures identified in the JNS Urgent Procedure: era.europa.eu/system/files/2022-11/jns_urgent_procedure_part_2_final_v1.0.pdf

Part II, Chapter 1: Risk Control Measures

Section 1.1: Measures to reduce the number of fixed brakes

Loaders / terminals

Measure	When to apply	Reason
Ensure that staff of loaders/terminal correctly load and unload the freight wagons by complying with the requirements for loading and unloading individually defined by the wagon keeper and manufacturer	When developing and updating the training plan <i>new¹⁾</i>	If the freight wagon is loaded / unloaded with applied brakes, this can lead to a locked brake rigging. ²⁾

1) Comparison to risk control measures identified in the JNS Urgent Procedure: era.europa.eu/system/files/2022-11/jns_urgent_procedure_part_2_final_v1.0.pdf

2) It is recommended to amend the UIC Loading Guidelines to include this point.

Part II, Chapter 1: Risk Control Measures

Section 1.1: Measures to reduce the number of fixed brakes

Infrastructure managers

Measure	When to apply	Reason
Supply the correct air quality (a harmonized air class quality to be used in maintenance is missing in the existing normative references - see Part II, Chapter 2, section 2.4)	Provide air for stationary brake testing rigs <i>new¹⁾</i>	If air quality is below recommended quality, long-term performance is not guaranteed.

1) Comparison to risk control measures identified in the JNS Urgent Procedure: era.europa.eu/system/files/2022-11/jns_urgent_procedure_part_2_final_v1.0.pdf

Part II, Chapter 1: Risk Control Measures

Section 1.1: Measures to reduce the number of fixed brakes

Workshops

Measure	When to apply	Reason
Supply the correct air quality as defined by ECM II in the maintenance plan	Provide air for stationary brake testing rigs <i>new¹⁾</i>	If air quality is below recommended quality, long-term performance is not guaranteed.

1) Comparison to risk control measures identified in the JNS Urgent Procedure: era.europa.eu/system/files/2022-11/jns_urgent_procedure_part_2_final_v1.0.pdf

Part II, Chapter 1

Risk control measures

Content

Part II, section 1.1: Measures to reduce the number of fixed brakes

Part II, section 1.2: Measures to detect fixed brakes

Part II, section 1.3: Measures to check wheels for extraordinary tread wear / deformation

Part II, Chapter 1: Risk Control Measures

Section 1.2: Measures to detect fixed brakes

Railway undertaking (RU) & Infrastructure managers (IM)

Measure	When to apply	Reason
<p>Detection of hot and thermal overloaded wheels with hot wheel and hot axle box detection systems</p> <ul style="list-style-type: none"> Hot wheel detection systems with appropriate alarm level (warm and hot), e.g.: <ul style="list-style-type: none"> Warm alarm: less than or equal to 300°C Hot alarm: between 300° and 500° C Hot axle box detection system: In case of any alarm on a tread braked freight train check in addition to the axle box also the wheel. <p>In case of any alarm, stop the train (based on infrastructure rules), (IM, RU)</p> <ul style="list-style-type: none"> Check of the wheels for signs of thermal overload (RU), Check of the wheel for extra ordinary wheel tread deformation (RU) In case of detection of thermal overload: the GCU requirements need to be followed, In case of extraordinary wheel tread deformation: Detach the wagon (RU), Change the wheelset and handover to off vehicle wheelset maintenance. (See section 1.3). 	<p>In case of any alarm, stop the train (based on infrastructure rules), (IM, RU):</p> <p><i>replaces measures 2.2.1 and 2.2.2¹⁾</i></p>	<p>Fixed brakes can cause thermal overload, leading to derailments, or fires alongside the tracks.</p>

1) Comparison to risk control measures identified in the JNS Urgent Procedure: era.europa.eu/system/files/2022-11/jns_urgent_procedure_part_2_final_v1.0.pdf

Part II, Chapter 1. : Risk Control Measures

Section 1.2 – Measures to detect fixed brakes

Best practice of trackside detection devices – RU & IM

- General recommendation for harmonization:
 - New systems on lines with tread braked freight application: combined HABD/HWD – systems;
 - Renewing of systems: also combined HABD/HWD – systems;
 - Average distance between detectors: 30 to 80 km;
 - Mounting of HWD based on risk assessment carried out by IM/ RU: e.g. at the end of long steep slopes, before long tunnels, ..;
 - Reminder: The additional measures after an alarm are defined in the result of the JNS Procedure → check of the wheels for signs of thermal overload and for extra ordinary wheel tread deformation (see Part II, Section 1.3).
- HWD - specific recommendations for harmonization:
 - Appropriate alarm level with “warm” alarm (e.g. 200 – 300°C) and “hot” alarm (e.g. 375 – 500°C);
 - The values for the temperature alarm level should be defined from RU and IM based at EN 15437-1, and based on their individual risk assessment, taking in account their individual context;
 - Depending on type of trains* (e.g trains with brake disc) different alarm level and subsequent actions should be applied, e.g. in Switzerland: train-specific actions after alarm.
- HADB – specific recommendations for harmonization:
 - Task Force did not identify any need to change the EN 15437 – 1 standard.

* Identification of the train by train-number or in the future by identification systems like RFID tags

Part II, Chapter 1: Risk Control Measures

Section 1.2: Measures to detect fixed brakes

Railway undertaking (RU) and Infrastructure Managers (IM)

Measure	When to apply	Reason
<p>Detection of hot wheels and thermal overload after fixed brakes or flaming brake blocks.</p> <ul style="list-style-type: none"> All staff in operation (train drivers, maintenance staff, signalers, etc.) who detect flaming brake blocks coming from trains, should activate the procedure to inform the train driver of the train with flaming brake blocks, to inform the problem occurred, to adopt the specific measures The measure includes the detection of fixed brake directly by the train driver by using systems such as rearview mirrors and cameras (if available). <p>In case of any irregularities, stop the train (based on infrastructure rules), (IM, RU)</p> <ul style="list-style-type: none"> Check of the wheels for signs of thermal overload (RU), Check of the wheel for extra ordinary wheel tread deformation (RU) In case of detection of thermal overload: the GCU requirements need to be followed, In case of extraordinary wheel tread deformation: Detach the wagon (RU), Change the wheelset and handover to off vehicle wheelset maintenance. (See Part II, Section 1.3). 	<p>In case of any fixed brake or flaming brake blocks, stop the train (based on infrastructure rules), (IM, RU):</p> <p><i>replaces measure 2.2.3)</i></p>	<p>Fixed brakes can cause thermal overload, leading to derailments, or fires alongside the tracks.</p>

Part II, Chapter 1: Risk Control Measures

Section 1.2: Measures to detect fixed brakes

Railway undertaking (RU)

Measure	When to apply	Reason
<p>Detection of consequences of fixed brakes by indicators on the brake blocks (examples on slide 57 and 58):</p> <ul style="list-style-type: none"> • Change of color on the block at the level of the interface between the block and the wheel tread, • Carbonized or fused brake blocks, • See the pictures next slides <p>• In case of detection of thermal overload: the GCU requirements need to be followed,</p> <p>• In case of extraordinary wheel tread deformation: Detach the wagon, change the wheelset and handover to off vehicle wheelset maintenance.</p>	<p>During any inspection of the wagon.</p> <p><i>replaces measure 2.2.4)</i></p>	<p>Fixed brakes can cause thermal overload, leading to derailments, or fires alongside the tracks.</p>

Part II, Chapter 1: Risk Control Measures

Section 1.2: Measures to detect fixed brakes

Examples



Brake block in normal conditions



Change of color and broken out brake block material

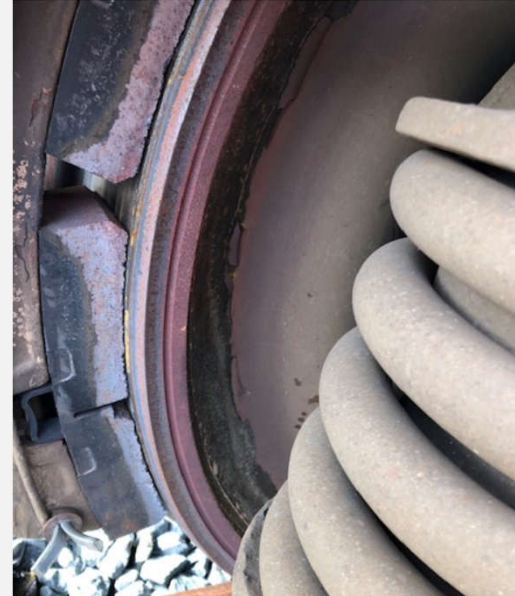

Change of color on the brake block and burned paint on the rim web transition of the wheel

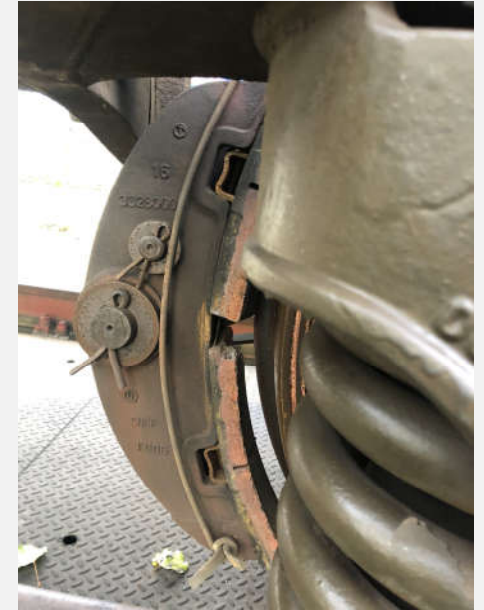

Change of color of the brake block

Part II, Chapter 1: Risk Control Measures

Section 1.2: Measures to detect fixed brakes

Examples



Fused brake block



Fused brake block



Carbonized brake block

Part II, Chapter 1

Risk control measures

Content

Part II, section 1.1: Measures to reduce the number of fixed brakes

Part II, section 1.2: Measures to detect fixed brakes

Part II, section 1.3: Measures to check wheels for extraordinary tread wear / deformation

Part II, Chapter 1: Risk Control Measures

Section 1.3: checks for extraordinary tread wear / deformation

Railway undertaking (RU) and Entity in Charge of Maintenance (ECM)

Measure	When to apply	Reason
<p>Visual check of the wheel tread has to be performed (RU, ECM). Extraordinary wheel tread deformation (see next slide) is not permitted</p> <ul style="list-style-type: none"> • Change the wheelset and hand over to off vehicle wheelset maintenance, apply the rules for change the wheelsets like for hot axle boxes • Apply the measures after thermal overload, see EN 15313 and GCU²⁾ (ECM) 	<p>After</p> <ul style="list-style-type: none"> • a fixed brake, • hot axle box detection alarm • hot wheel detection alarm • a brake incident (see slides before) • detecting flames or being informed about flames on the train • or any other signs of thermal overload of a wheel <p><i>replaces measure 2.3.1)</i></p>	<p>Wheels with extraordinary tread wear/deformation might lead to derailments.</p>

1) Comparison to risk control measures identified in the JNS Urgent Procedure: era.europa.eu/system/files/2022-11/jns_urgent_procedure_part_2_final_v1.0.pdf

2) Extraordinary wheel tread deformation will be implemented in the next version of the GCU (expected in 2025)

Part II, Chapter 1: Risk Control Measures

Section 1.3: checks for extraordinary tread wear / deformation

Railway undertaking (RU) and Entity in Charge of Maintenance (ECM)



Extraordinary wheel tread deformation on the outer side of the tread

The measurement tool is not part of the assessment



Extraordinary wheel tread deformation near the flange

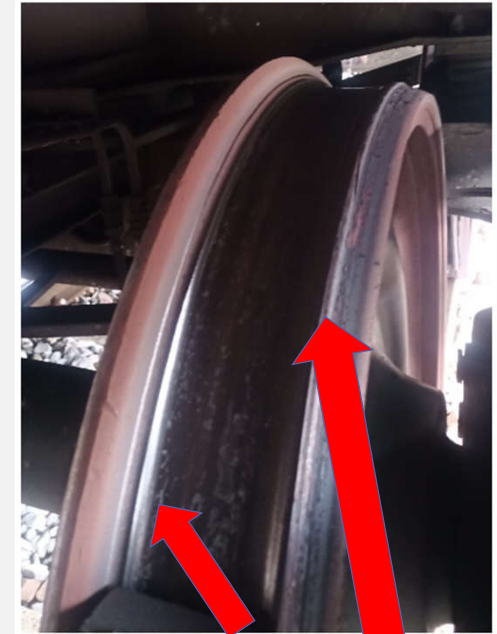

Extraordinary wheel tread deformation on the outer side of the tread and near the flange

Part II, Chapter 2

Changes in legislation and standards

Content

Part II, section 2.1: Composite brake blocks

Part II, section 2.2: Fire Safety

Part II, section 2.3: Trackside detection systems for hot wheels and hot axle boxes

Part II, section 2.4: Brake air quality

Part II, Chapter 2. : Changes in legislation and standards

Section 2.1 – Composite brake blocks

Overview - EU legislative framework

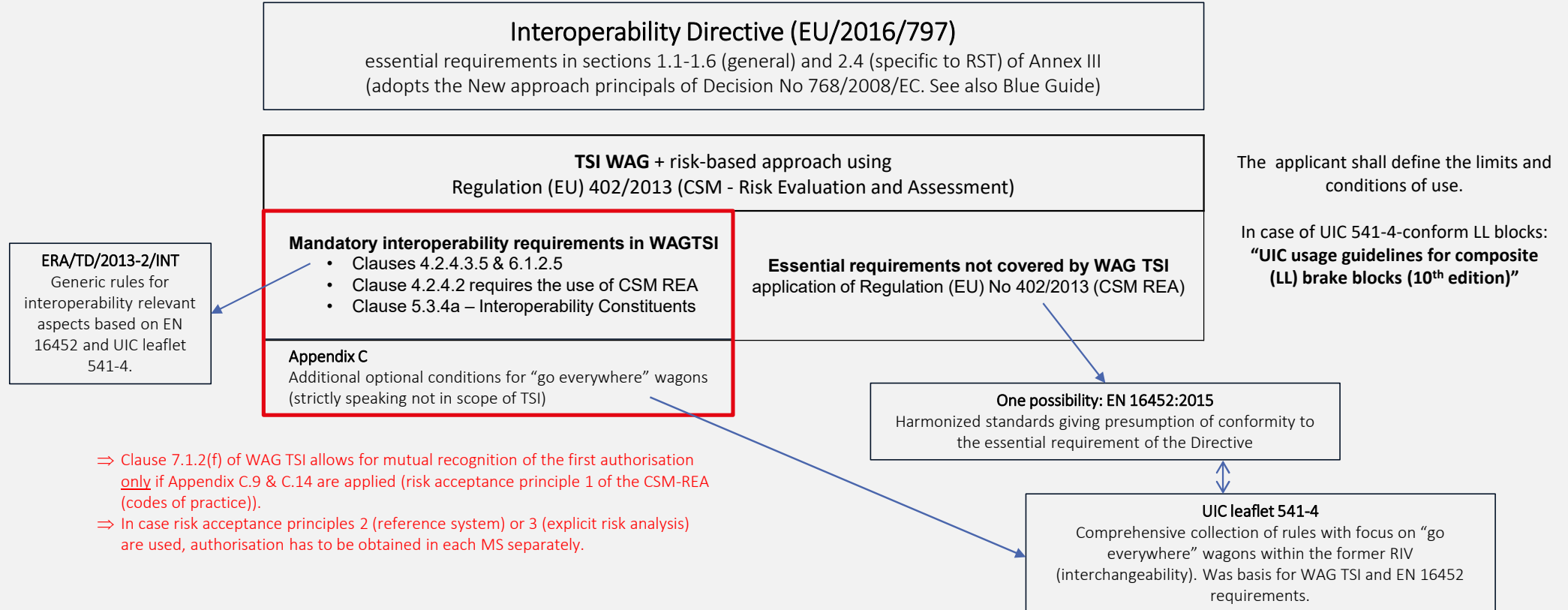

Part II, Chapter 2. : Changes in legislation and standards

Section 2.1 – Composite brake blocks

Comparison of product requirements

	Interoperability Directive (EU/2016/797)* (New approach acc. to Blue guide) (Annex III 1.1-1.6, 2.4)		Alternative to new approach No additional risk assessment needed		EN 16452: 2015 + A1:2018	UIC 541-4:2020 (6th ed.)
	Interoperability: TSI WAG (Clause 4.2.4.3.5) (without Annex C) acc. to clause 6.1.2.5	Essential requirements not covered by TSI	TSI WAG (clause 7.1.2) (mutual recognition of first authorization) (Necessity of fulfillment of C.9, C.14)	TSI WAG annex C.9		
dynamic friction behaviour	required		required	required	required	required
metallic inclusions	not required	Required if indicated by risk assessment	required	required	should be done	required
winter performance	only required if friction element is intended to be suitable for severe environmental conditions		required	required	required	required
fusible test	not required	Required if indicated by risk assessment	required	required	required	required
shuntage test	only required if friction element is intended to be suitable for train detection by systems based on track circuits also mandatorily required by 7.1.2		required	required	should be done	required
mechanical properties	required		required	required	required	required
static friction behaviour	required		required	required	required	required
Slip test	not required	Required if indicated by risk assessment	required	required	recommended	required
Service test	not required	Required if indicated by risk assessment	required	required	recommended	required

Part II, Chapter 2. : Changes in legislation and standards

Section 2.1 – Composite brake blocks

Comparison of product requirements

	UIC 541-4:2020 (6th ed.)	EN 16452:2015 + A1:2018	TSI WAG ERA/TD/2013-02/INT version 3.0, 27/11/2015
dynamic friction behaviour	164 brakings 1.8 t and 11.25 t 120 kph max	149 brakings 1.8 t and 11.25 t 120 kph max	149 brakings masses defineable max speed defineable
metallic inclusions	MPU test is similar for UIC and EN		Not required for interoperability (Required if indicated by risk assessment)
winter performance	Content of winter performance test (track test) is similar for all; Possibility to perform tests at RTA facilities described only in UIC Possibility of bench tests described in UIC and TSI <i>(Feasibility and assessment of results using TSI description is questionable)</i>		
fusible test	Fusible test is similar for UIC and EN		Not required for interoperability (Required if indicated by risk assessment)
shuntage test	Shuntage test (subscale) is similar for all UIC and EN provide the possibility of track tests		
mechanical properties	Content of the mechanical properties test is similar for all		
static friction behaviour	20 brakings 5 kN, 14 kN, 30 kN, 40 kN	20 brakings 1/4, 1/2, 3/4 of Fpbmax and Fpbmax Fpbmax defineable	20 brakings 1/4, 1/2, 3/4 of Fpbmax and Fpbmax Fpbmax defineable
Slip tests	Identically		Not required for interoperability (Required if indicated by risk assessment)
Service test	20 axles 12 months 60000 km each axle	5 wagons 12 months 60000 km each axle	Not required for interoperability (Required if indicated by risk assessment)
	Identical inspections slight differences in content during the intermediate inspections		

Not mandatory but
recommended

Part II, Chapter 2. : Changes in legislation and standards

Section 2.1 – Composite brake blocks

Conclusion

- The *Usage guidelines for composite (LL) brake blocks* published by UIC provide the basis for the limits and conditions of use for LL blocks.
[Link to UIC usage guideline](#)
- There is no need to change the content, however it should be transferred to more prominent documents (see Recommendations)
- The LL - brake block types IB116* and J847, are conform to TSI WAG Appendix C.9 which equals to conformity to UIC 541-4:2010.

Part II, Chapter 2. : Changes in legislation and standards

Section 2.1 – Composite brake blocks

Conclusion

- For blocks not conforming to TSI WAG Appendix C.9 and C.14 an explicit risk assessment has to be carried out to cover the risk linked to a locked brake scenario. The vehicle using these block types has to be authorised by each NSA separately.
- UIC 541-4:2020 represents currently the most developed requirements for composite brake blocks. The JNS NP task force recommends to update the WAG TSI and EN 16452 accordingly.
- Clause 4.2.4.2 of TSI WAG requires risk assessment for the braking system. UIC brake system in accordance with Appendix C.9 and C.14 does not need a risk assessment

Part II, Chapter 2. : Changes in legislation and standards

Section 2.1 – Composite brake blocks

Recommendations

Usage guidelines for composite (LL) brake blocks

- Transfer content to :
 - EN 16452 concerning the brake blocks;
 - UIC 541-4 concerning the brake operation;
 - EN 15313 concerning the wheels.

EN 16452:2015 (currently under revision)

- Align with the most recent version of UIC 541-4;
- Integrate the generic approach of ERA/TD/2013-02/INT version 3.0 of 27/11/2015.

WAG TSI

- Refer to future EN 16452 as described above instead of ERA/TD/2013-2/INT version 3.0 of 27/11/2015 and UIC 541-4;
- Discuss removal of point (f) of clause 7.1.2 of WAG TSI:2023 in the TSI working party.

Part II, Chapter 2

Changes in legislation and standards

Content

Part II, section 2.1: Composite brake blocks

Part II, section 2.2: Fire Safety

Part II, section 2.3: Trackside detection systems for hot wheels and hot axle boxes

Part II, section 2.4: Brake air quality

Part II, Chapter 2. : Changes in legislation and standards

Section 2.2 – Analysis regarding fire safety

Overview - EU legislative framework

- In the WAG TSI 2023, fire safety on board of freight wagons refers to
 - “barriers”,
 - “materials”,
 - “cables” and
 - “flammable liquids”.
- There are no cables and flammable liquids near the brake blocks of normal freight wagons.
- Spark arrester plates might touch requirements on barriers and materials.

➔ **Analysis is focusing on “Barriers” and “Materials” only.**

Part II, Chapter 2. : Changes in legislation and standards

Section 2.2 – Analysis regarding fire safety

Overview - EU legislative framework

Requirements on “Barriers” and “Materials” in EU legislation

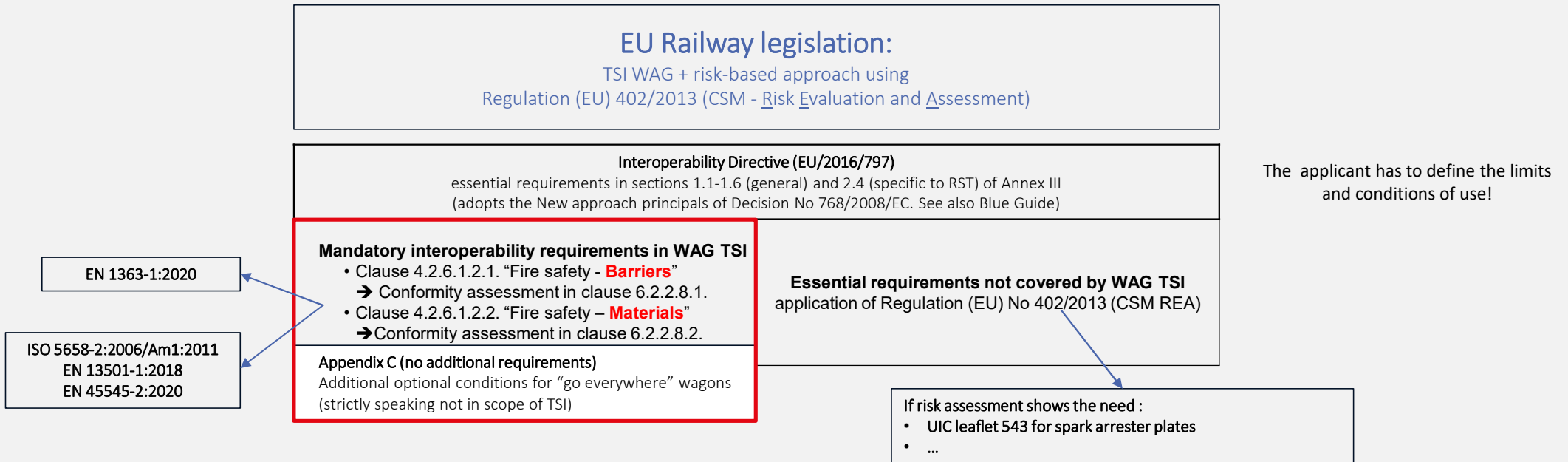

Part II, Chapter 2. : Changes in legislation and standards

Section 2.2 – Analysis regarding fire safety

Requirements in the WAG TSI on “Barriers”

4.2.6. *System protection*

4.2.6.1. *Fire safety*

4.2.6.1.1. *General*

All significant potential fire sources (high risk components) on the unit shall be identified. The fire safety aspects of the unit design shall be aimed at:

- preventing a fire from occurring,
- limiting the effects if a fire occurs.

The goods carried on the unit are not part of the unit and do not have to be taken into account in the conformity assessment.

4.2.6.1.2. *Functional and technical specification*

4.2.6.1.2.1. Barriers

In order to limit the effects of fire, fire barriers with integrity of at least 15 minutes shall be installed between the identified potential fire sources (high risk components) and the carried load.

The demonstration of conformity is described in point 6.2.2.8.1

6.2.2.8. *Fire safety*

6.2.2.8.1. *Barriers*

► **M5** Barriers shall be tested in accordance with the specification referenced in Appendix D Index [19]. ◀ Steel sheets of at least 2 mm thickness and aluminium sheets of at least 5 mm thickness are deemed to comply with the integrity requirements without testing.

Index	Characteristics to be assessed	TSI point	Mandatory standard point
[19]	EN 1363-1:2020 Fire resistance tests - Part 1: General Requirements		
[19.1]	Barriers	6.2.2.8.1	4 to 12

Part II, Chapter 2. : Changes in legislation and standards

Section 2.2 – Analysis regarding fire safety

Requirements in the WAG TSI on “Barriers”

Barriers

- Neither clause 6.2.2.8.1 of TSI WAG nor the referenced EN 1363-1, nor any other EN (e.g. EN45545-ff) deal with spark arrester plates. Only UIC leaflet 543 contains requirements on them.
- RID does also not contain any technical requirements on spark arrester plates.
- If the risk assessment according to Regulation (EU) No 402/2013 (CSM REA) indicates a fire risk caused by sparks from the brake blocks, one way for the manufacturer to control the risk might be the application of the UIC leaflet 543.
- The spark arrester plates according to UIC 543 are defined as 2mm thick and would therefore be themselves compliant with the WAG TSI requirements on barriers.

→ **Question 1:** Are requirements on spark arrester plates missing in WAG TSI or in the EN?

→ **Question 2:** Is UIC leaflet 543:2018 on spark arrester plates still sufficient?

Part II, Chapter 2. : Changes in legislation and standards

Section 2.2 – Analysis regarding fire safety

Question 1: Are requirements on spark arrester plates missing in WAG TSI or EN

- JNS TF is of the opinion that spark arrester plates are specific “Barriers”. However, spark arresters are currently not sufficiently described for freight wagons.
- Therefore, it is recommended to refer in the WAG TSI to a new ERA Technical Document with the requirements of the UIC 543:2018 on spark arresters.
- In addition, particular non-EU manufacturers might not be aware of the UIC leaflet due to its unofficial status. A good wagon builder should have respected older best practice – even if not legally binding. But there is a risk that some wagon builders would not apply this best practice.

Answer to Question 1:

- ➔ JNS TF will submit a change request for the WAG TSI (see next slide).
- ➔ Proposal will contain reference to an ERA Technical Document with UIC requirements.
- ➔ The proposed ERA TD might later be transferred into an EN to which the TSI can refer.

Part II, Chapter 2. : Changes in legislation and standards

Section 2.2 – Analysis regarding fire safety

Proposal for a change in the WAG TSI

Addition to clause 4.2.6.1.2.1. in WAG TSI¹⁾:

4.2.6.1.2.1. Barriers and spark arresters

In order to limit the effects of fire, fire barriers with integrity of at least 15 minutes shall be installed between the identified potential fire sources (high risk components) and the carried load.

The following tread braked units shall be equipped with spark arresters:

- Units with floors made of inflammable materials
- Flat units without flooring
- Flat units with gaps in the flooring to house the tread-braked wheels except units solely used for the transport of incombustible products (e.g. steel products)

The spark arresters shall comply with the requirements of sections of ERA Technical Document ERA/TD/2024-0x/xxx.

1) Reference document: COMMISSION REGULATION (EU) No 321/2013 of 13 March 2013 concerning the technical specification for interoperability relating to the subsystem 'rolling stock — freight wagons' of the rail system in the European Union, including amendments from Regulations (EU) 2015/924, (EU) 2019/776, (EU) 2020/387 and (EU) 2023/1694.

Part II, Chapter 2. : Changes in legislation and standards

Section 2.2 – Analysis regarding fire safety

Question 2: Is UIC leaflet 543:2018 on spark arrester plates sufficient?

- Only point 3 in the UIC leaflet refers to spark arrester plates for block braked wagons
- Applicable only to wagons with flammable floor and flat wagons without or with interrupted floor
- Annex A: Dimensions for wagons with single axles
- Annex B: Dimensions for wagons with bogies

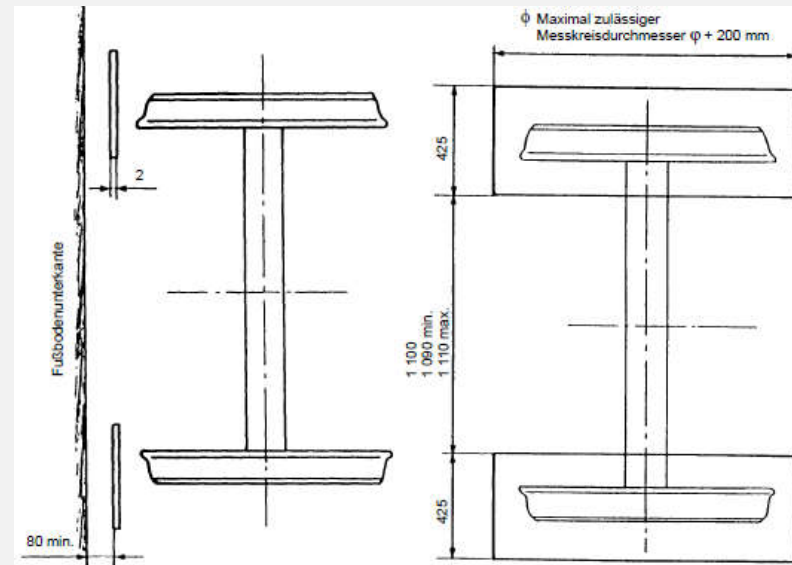
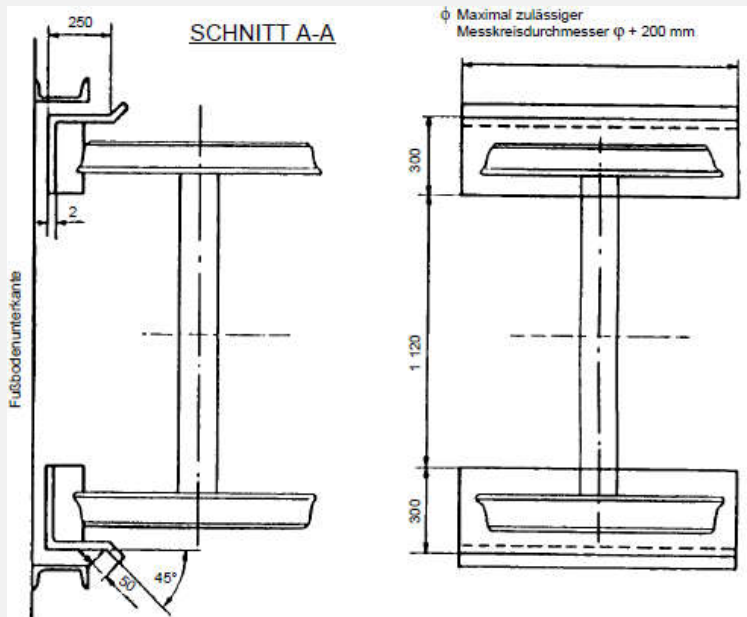

- Length of the spark arrester plates is nom. wheel diameter new (e.g. 920mm) plus 200mm

Part II, Chapter 2. : Changes in legislation and standards

Section 2.2 – Analysis regarding fire safety

Question 2: Is UIC leaflet 543:2018 on spark arrester plates sufficient?

- In 2021, during the JNS urgent procedure, the size of the spark arrester plates in accordance with UIC leaflet 543:2018 had been compared with the results of the dynamometer bench tests from DB of 2020 regarding the fire protection evaluation of composite brake blocks.
- The outcome was that the size as defined in the UIC leaflet 543:2018 is still sufficient.
- However, no distinction is made between tread- and disc braked units in the UIC 543:2018.
- It also has to be checked, if the references from 2018 to the RID are still up to date.

Answer to Question 2:

- ➔ From the technical point of view, the requirements are still sufficient, editorially updates might be needed.
- ➔ The change request of the JNS TF will introduce a distinction between tread- and disc braked units and will consider needed updates.

Part II, Chapter 2. : Changes in legislation and standards

Section 2.2 – Analysis regarding fire safety

Requirements in the WAG TSI on “Materials”

4.2.6.1.2.2. Materials

All permanent materials used on the unit shall have limited ignitability and flame spread properties, unless:

- the material is separated from all potential fire risks on the unit by a fire barrier and the safe application is supported by a risk assessment, or
- the component has a mass < 400 g, and is located within a horizontal distance of ≥ 40 mm and a vertical distance of ≥ 400 mm to other non-tested components.

The demonstration of conformity is described in point 6.2.2.8.2.

6.2.2.8.2. Materials

Testing of the materials ignitability and flame spread properties shall be performed in accordance with the specification referenced in Appendix D Index [20] for which the limit value shall be $CFE \geq 18$ kW/m².

For rubber parts of bogies, the testing shall be performed in accordance with the specification referenced in Appendix D Index [22] for which the limit value shall be $MARHE \leq 90$ kW/m² under the test conditions set out in the specification referenced in Appendix D Index [22].

For the following materials and components the fire safety requirements are deemed to comply with the required ignitability and flame spread properties:

- Wheelsets, coated or uncoated,
- metals and alloys with inorganic coatings (such as, but not limited to: galvanised coating, anodic coating, chromate film, phosphate conversion coating),
- metals and alloys with an organic coating with a nominal thickness less than 0,3 mm (such as, but not limited to paints, plastic coating, asphaltic coating),
- metals and alloys with a combined inorganic and organic coating of which the nominal thickness of the organic layer is less than 0,3 mm,
- glass, stoneware, ceramic and natural stone products,
- materials that meet the requirements of category C-s3, d2 or higher in accordance with the specification referenced in Appendix D Index [21].

Index	Characteristics to be assessed	TSI point	Mandatory standard point
[20]	ISO 5658- 2:2006/Am1:2011 Reaction to fire tests — Spread of flame — Part 2: Lateral spread on building and transport products in vertical configuration		
[20.1]	Testing of the materials ignitability and flame spread properties	6.2.2.8.2	5 to 13
[21]	EN 13501-1:2018 Fire classification of construction products and building elements - Part 1: Classification using data from reaction to fire tests		
[21.1]	Material properties	6.2.2.8.2	8
[22]	EN 45545-2:2020 Railway applications - Fire protection on railway vehicles -Part 2: Requirements for fire behaviour of materials and components		
[22.1]	Test conditions	6.2.2.8.2	Ref T03.02 of Table 6

Materials

- Components around the brake blocks are made of metals or alloys with an organic coating with a nominal thickness of less than 0,3mm.
- Materials around the brake blocks are compliant with the TSI WAG requirements on materials.
- The brake blocks themselves are deemed burnable, so demonstration to be compliant with clause 6.2.2.8.2 of the WAG TSI 2023 (limit value of CFE $\geq 18 \text{ kW/m}^2$) is to be demonstrated by the block manufacturer.

→ Current requirements on materials in WAG TSI and ENs are considered sufficient

Part II, Chapter 2

Changes in legislation and standards

Content

Part II, section 2.1: Composite brake blocks

Part II, section 2.2: Fire Safety

Part II, section 2.3: Trackside detection systems for hot wheels and hot axle boxes

Part II, section 2.4: Brake air quality

Part II, Chapter 2. : Changes in legislation and standards

Section 2.3 – Trackside detection systems

Proposals for amendments in TSI INF

Addition of a new clause in TSI INF¹):

4.2.13 Track side detection systems for monitoring trains

The IM shall check using the CSM's (notwithstanding the responsibility and accountability of other actors and third parties) the need for track side Hot Axle Box Detection Systems and Hot Wheel Detection Systems. If the systems are needed, they shall be able to trigger an alarm to ensure that appropriate restrictions are applied to the train.

Regarding the interfaces to TSI WAG, changes to related clauses in chapter 4.3 of TSI INF are proposed on the next slide (correspondence table nr. 16 - “Interfaces with the rolling stock subsystem”).

For TSI Loc&Pass and possible other TSIs, a similar exercise still needs to be done.

The ongoing UIC Project ‘NETWORK MONITOR’ will address track side Hot Axle Box Detection Systems and Hot Wheel Detection systems. The outcome of this project may lead to additions to this clause of the TSI INF (see also Part II, Chapter 3).

1) Reference document: COMMISSION REGULATION (EU) No 1299/2014 of 18 November 2014 on the technical specifications for interoperability relating to the ‘infrastructure’ subsystem of the rail system in the European Union, Commission Implementing Regulation (EU) 2023/1694 of 10 August 2023

Part II, Chapter 2. : Changes in legislation and standards

Section 2.3 – Trackside detection systems

Proposals for amendments in TSI INF

4.3.1 Interfaces with the rolling stock subsystem

- Add a new line in table 16 „Interfaces with the rolling stock subsystem, ‘Freight Wagons TSI’”

Interface	Reference Infrastructure TSI	Reference Conventional Rail Freight Wagons TSI
Hot Axle Box Detection Systems	4.2.13 Track side detection systems for monitoring trains	4.2.3.4. Axle bearing condition monitoring

The same has to be done in the table of correspondence in table 15 „Interfaces with the rolling stock subsystem, ‘Locomotives and Passenger Rolling Stock TSI’.

Appendix B Tabel 37

Characteristics to be assessed	New line or Upgrade/renewal project		Particular assessment procedures
	Design Review	Assembly before putting into service	
	1	2	3
4.2.13 Track side detection systems for monitoring trains	n.a.	n.a.	

Part II, Chapter 2. : Changes in legislation and standards

Section 2.3 – Trackside detection systems

Proposals for additions and amendments in TSI OPE¹⁾

4.2.3.6.2 *Advice to train drivers*

In any case of degraded operation associated with the infrastructure manager's area of responsibility, the infrastructure manager shall give formal instructions to drivers on what measures to take in order to safely overcome the degradation.

In case of defined anomalies to the vehicles of a train signaled by the trackside detection systems [link with TSI INF], the signaller must apply the relevant restrictions, if the system itself has not done so automatically, and inform the driver with available information relating to the alarm reported.

4.2.3.5.1. *Recording of monitoring data outside the train*

As a minimum, the infrastructure manager shall record the following data:

- the failure of lineside equipment associated with the movement of trains (signalling, points etc.);
- the detection of an overheating axle bearing or wheel, if fitted;
- safety related communication between the train driver and signaller

Part II, Chapter 2. : Changes in legislation and standards

Section 2.3 – Trackside detection systems

Proposals for a new standard on Hot Wheel Detection systems (HWD)

- Development of a new standard for interface and design requirements of hot wheel detection systems (HWD);
- Based on the EN 15437-1 “Railway applications – Axlebox condition monitoring – interface and design requirements”;
- Proposed content (in addition to slide 54):
 - General information about HWD;
 - Interface recommendations for target area for wheels, axle- or wheel-mounted brake discs;
 - Alarm level (hot/warm) with informative examples for thresholds;
 - Relevant parameters for the installation on the network.

Part II, Chapter 2

Changes in legislation and standards

Content

Part II, section 2.1: Composite brake blocks

Part II, section 2.2: Fire Safety

Part II, section 2.3: Trackside detection systems for hot wheels and hot axle boxes

Part II, section 2.4: Brake air quality

Part II, Chapter 2. : Changes in legislation and standards

Chapter 2.4 – Analysis regarding brake air quality

Proposals for a new standard on brake air quality

- The Task Force recommends to harmonize brake air quality requirements based on the air quality classes defined in the new ISO 4975 standard, covering following applications:
 - a) implementation of air supply systems on the locomotives;
 - b) design of pneumatic parts of the brake system;
 - c) stationary air supply devices (maintenance workshops, shunting yards, test rigs, etc..).
- For a) : during the revision of EN 14198 – *Railway applications – Braking – Requirements for the brake system of trains hauled by locomotives*, brake air quality requirements for the locomotive air supply units where defined based on ISO 4975 within CEN/TC256/WG47. It is currently in status “comments resolution”;
- For b) : the JNS Task Force recommends the CEN/TC256/WG47 to consider the new ISO standard during the revision of standards for pneumatic parts;
- For c) : The JNS Task Force recommends UIC to take this task forward for the stationary air supply devices;
- Afterwards, subsequent changes in the TSI shall be discussed in the TSI working parties.

Part II, Chapter 3

Research needs and related ongoing projects

Content

Part III, section 3.1: block and wheel behavior in a fixed brake situation

Part III, section 3.2: rolling stock side brake test and monitoring systems

Part III, section 3.3: track-side detection systems

Part II, Chapter 3. : Research needs and related ongoing projects

Section 3.1 – Block and wheel behavior in a fixed brake situation

Concept

- Objective :
 - definition of test bench tests for further analyses of the conditions under which the blocks will be flamed and / or plastic deformation of the wheel tread will occur
- Main questions:
 1. What is the influence from the wheel-rail contact force on the hot wheel tread?
 2. Under which conditions (forces, time, speed) will the blocks be flamed or suffer unexpected wheel tread deformations?
 3. Cof (coefficient of friction) development after thermal overloading of organic LL-blocks
- Deliverables:
 - Performing thermal and / or plastic deformation simulation of the wheel
 - Comparison between locked brake test program and real conditions on basis of analysis
- Later to be answered depending on the other results:
 - Are the requirements of homologation in the validation protocol representative of the conditions in operation after analysis the relevant cases?

Part II, Chapter 3. : Research needs and related ongoing projects

Section 3.1 – Block and wheel behavior in a fixed brake situation

Results of Task Force analyses

Regarding question 1 (see slide 88):

- The Task Force members started to analyse the UIC report B 169 / RP 23: “Wheels - Definition of the extraordinary thermomechanical stresses on wheels due to composite brake blocks” from 2007. This report did not provide a sufficient answer.
 - However, the Task Force identified the UIC sector project WP1.2. that attempts to answer the question “What is the influence of the wheel temperature on mechanical properties and wear development?” (outcome of this project should also answer question 1)
- ➔ The Task Force recommends to wait for the results of UIC sector project WP1.2

Regarding question 2 (see slide 88):

- The Task Force analysed if Railway Undertakings (RU) or Infrastructure Managers (IM) could provide information on the development of flames after fixed brakes with the intention of determining the speed, distance and application force.
It was concluded that the RUs and IMs cannot provide such information.
- ➔ The Task Force recommends to wait for the results of UIC sector project WP1.2

Part II, Chapter 3. : Research needs and related ongoing projects

Section 3.1 – Block and wheel behavior in a fixed brake situation

Results of Task Force regarding the Coefficient of Friction after a fixed brake event

Regarding question 3 (see slide 88):

- The Task Force performed a service test (A11, UIC 541-4) “in real service conditions” on a set of damaged brake blocks of type IB 116* which was involved in a fixed brake event.
- The results of this test were compared with a similar test (same program) with a standard wheel and new blocks.
- ➔ It was concluded that using a brake block damaged by a fixed brake event does not generate a higher risk for damages to the wheel.
- ➔ The Task Force does not see the need for further research concerning composite brake block-wheel interaction in a fixed brake situation.

Part II, Chapter 3

Research needs and related ongoing projects

Content

Part III, section 3.1: block and wheel behavior in a fixed brake situation

Part III, section 3.2: rolling stock side brake test and monitoring systems

Part III, section 3.3: track-side detection systems

Part II, Chapter 3. : Research needs and related ongoing projects

Section 3.2 – rolling stock side brake test and monitoring systems

First overview of related ongoing projects

- **VTG** is currently testing two different brake monitoring systems, which could be upgraded to show brake abnormalities during travelling as information to the train driver :
 - A. Together with SBB Cargo on TWIN-III double pocket wagons
Manufacturer of the equipment: PJM
Plan is to equip 75 wagons (mixed traffic with Sgnss from SBB Cargo, which are also equipped with similar systems)
 - B. Together with BoxXpress on Sgnss 80' wagons
Manufacturer of the equipment: SIEMENS
Plan is to equip 56 wagons (aim is to run two complete trainsets of 23 wagons)
- **DB** project AmaBPro (similar to the VTG projects)
- Technical solution developed by **Knorr Bremse**
 - In 2020, approximately 130 freight wagons were equipped with Brake System Monitoring systems similar to the VTG system. A milage of more than 1 Mio km where reached. Collected data was shared using a cloud-based IT system.
A system to support “Automated Brake Tests” is currently under development and field test are planned.

Part II, Chapter 3. : Research needs and related ongoing projects

Section 3.2 – rolling stock side brake test and monitoring systems

VTG project A : Double-pocket wagons Sdggmrss TWIN-III

Digital Innovation in Rail Freight

› Small battery-based telematics box

Position, mileage;
limited monitoring capabilities, no automation



› Advanced monitoring and automation system

Full real-time monitoring capabilities for assets and cargo, power supply, condition based maintenance, in-train communication, safety and non-safety relevant process automation

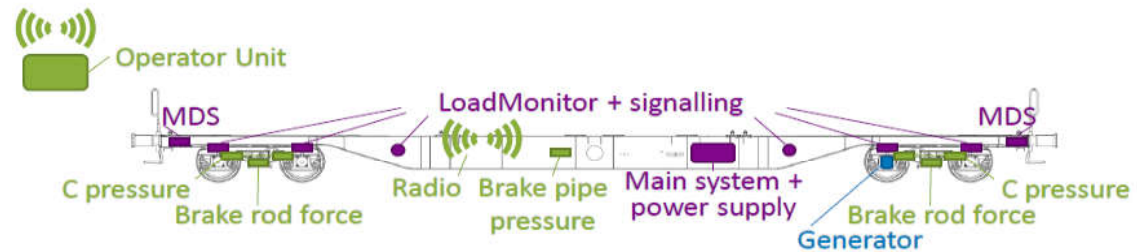

› DAC – Digital Automated Coupler

Automated (de-)coupling, cooperation PJM/Voith

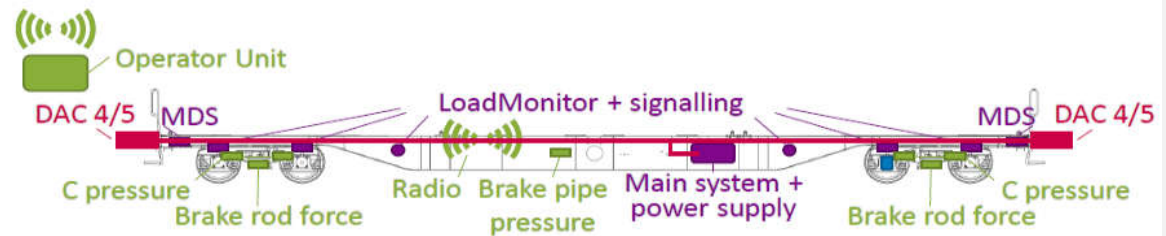

Part II, Chapter 3. : Research needs and related ongoing projects

Section 3.2 – rolling stock side brake test and monitoring systems

VTG project A : Double-pocket wagons Sdggmrss TWIN-III

WaggonTracker: One Modular System for all Use Cases

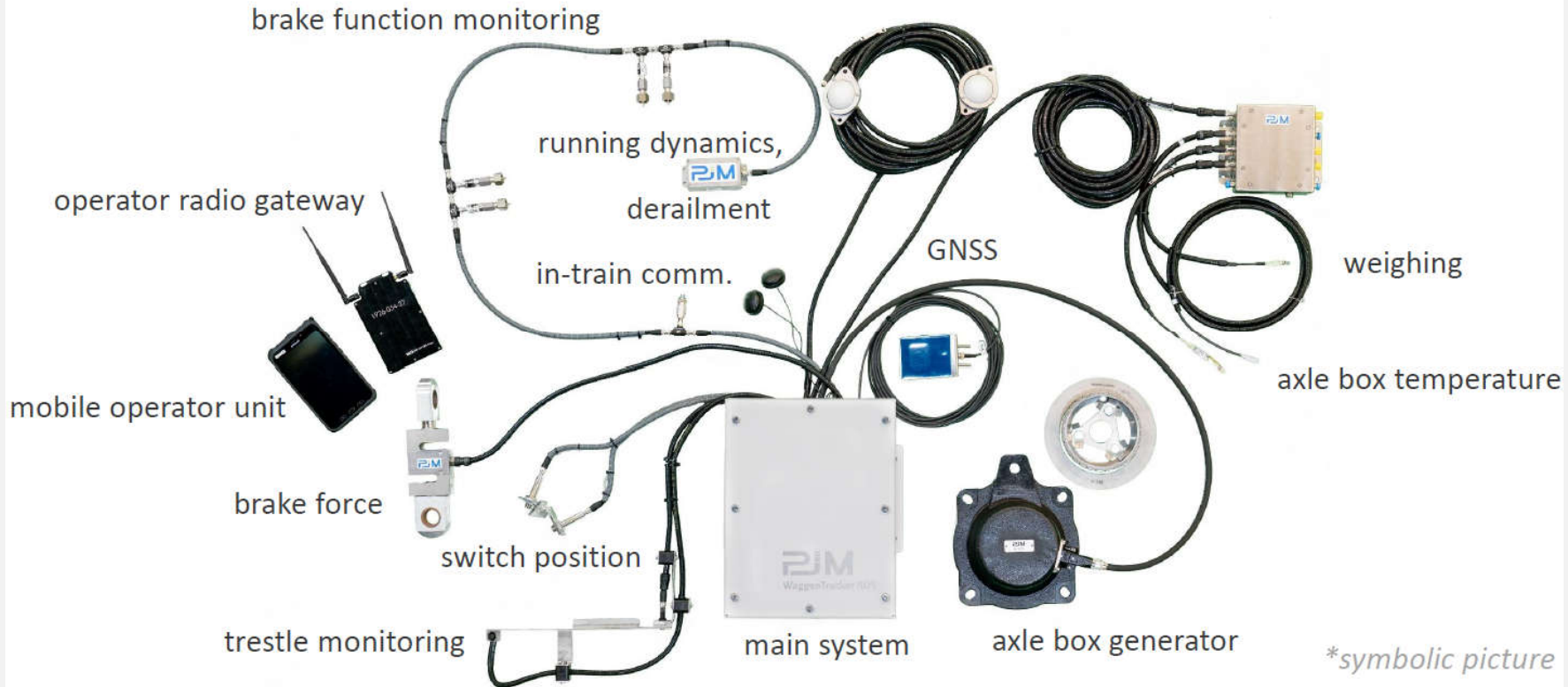

Part II, Chapter 3. : Research needs and related ongoing projects

Section 3.2 – rolling stock side brake test and monitoring systems

VTG project A : Double-pocket wagons Sdggmrss TWIN-III

PJM WaggonTracker Range of Services

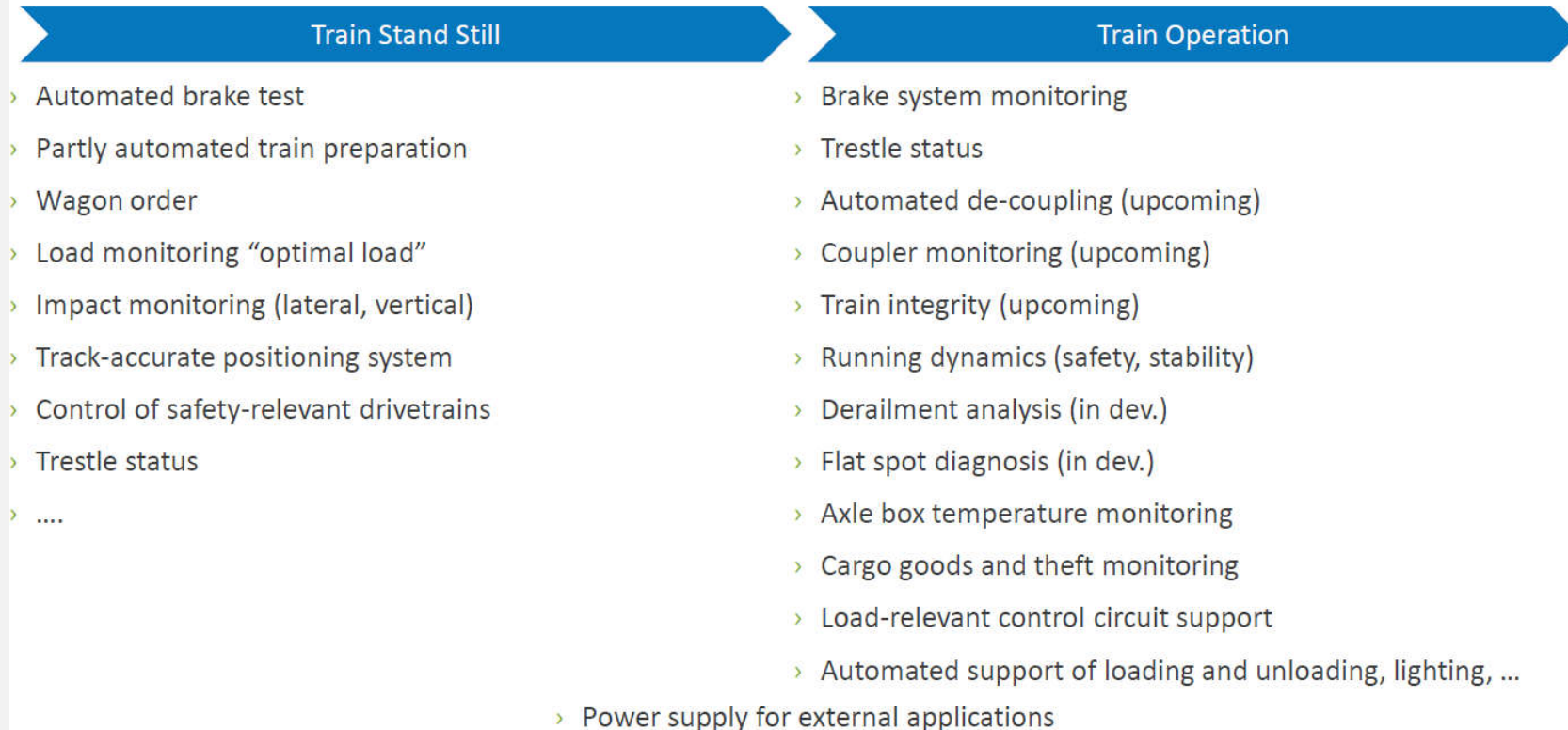

Part II, Chapter 3. : Research needs and related ongoing projects

Section 3.2 – rolling stock side brake test and monitoring systems

VTG project A : Double-pocket wagons Sdggmrss TWIN-III

In-Train Communication → Intelligent Freight Train

- › In-train long-range wireless system
- › Direct communication
- › Wagon in stand-by
- › Relaying possible

- › Designed for maximum availability
- › Encrypted, secure connection
- › locally available, inter-operable, fully integrated, open interfaces



› In Cooperation with

Rail Cargo Wagon
Member of OBB

SBB CFF FFS Cargo

MERCITALIA RAIL
GRUPPO FERROVIE DELLO STATO ITALIANE

Part II, Chapter 3. : Research needs and related ongoing projects

Section 3.2 – rolling stock side brake test and monitoring systems

VTG project A : Double-pocket wagons Sdggmrss TWIN-III

Intelligent Freight Train – Real-Time Monitoring during Train Operation

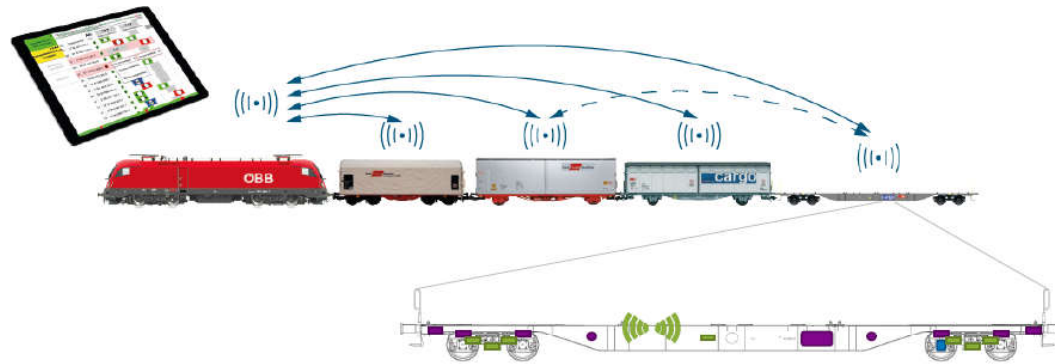

Real-time monitoring

- › Brake status of last waggon
- › End of train status
- › Derailment diagnosis
- › Hot axle box warning
- › Automatic/remote controlled park brake
- › Automatic/remote controlled de-coupling
- › Diagnosis of faulty braking wagons during operation (adjust pressure)
- › Safety relevant measurement of trestle/hitch
- › Base for future requirements

Developed in cooperation with



Part II, Chapter 3. : Research needs and related ongoing projects

Section 3.2 – rolling stock side brake test and monitoring systems

VTG project A : Double-pocket wagons Sdggmrss TWIN-III

Automated Brake Test and Partly Automated Train Preparation

Main Scope

- › Reliable and safe detection of brake state
- › Increase safety, efficiency, availability

Support Train Preparation

- › G/P switch position
- › Train length
- › Brake calculation
- › Verification of train wagon order

Base For Further Applications

- › Trestle / hitch: safe determination of kingpin and lock state
- › Brake system monitoring during train operation (faulty braking, train separation, flat spots, etc.)

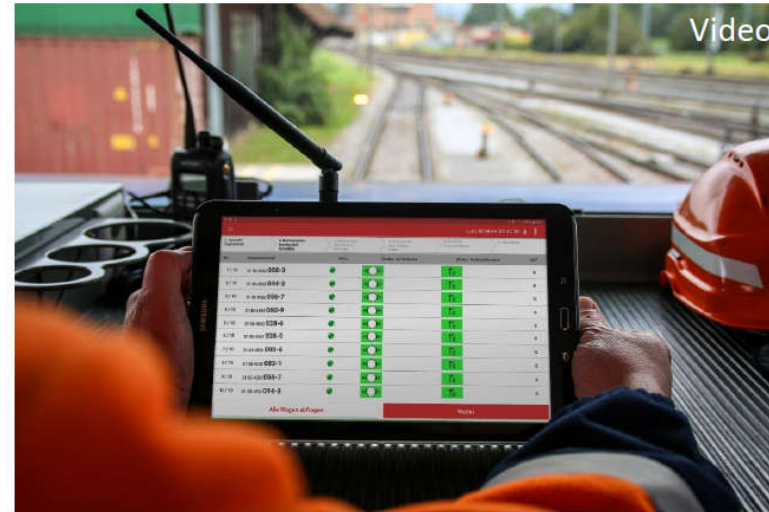

Developed in cooperation with

Rail Cargo Wagon
Member of OBB

SBB CFF FFS Cargo

Part II, Chapter 3. : Research needs and related ongoing projects

Section 3.2 – rolling stock side brake test and monitoring systems

VTG project A : Double-pocket wagons Sdggmrss TWIN-III

Automated Brake Test – System Integration

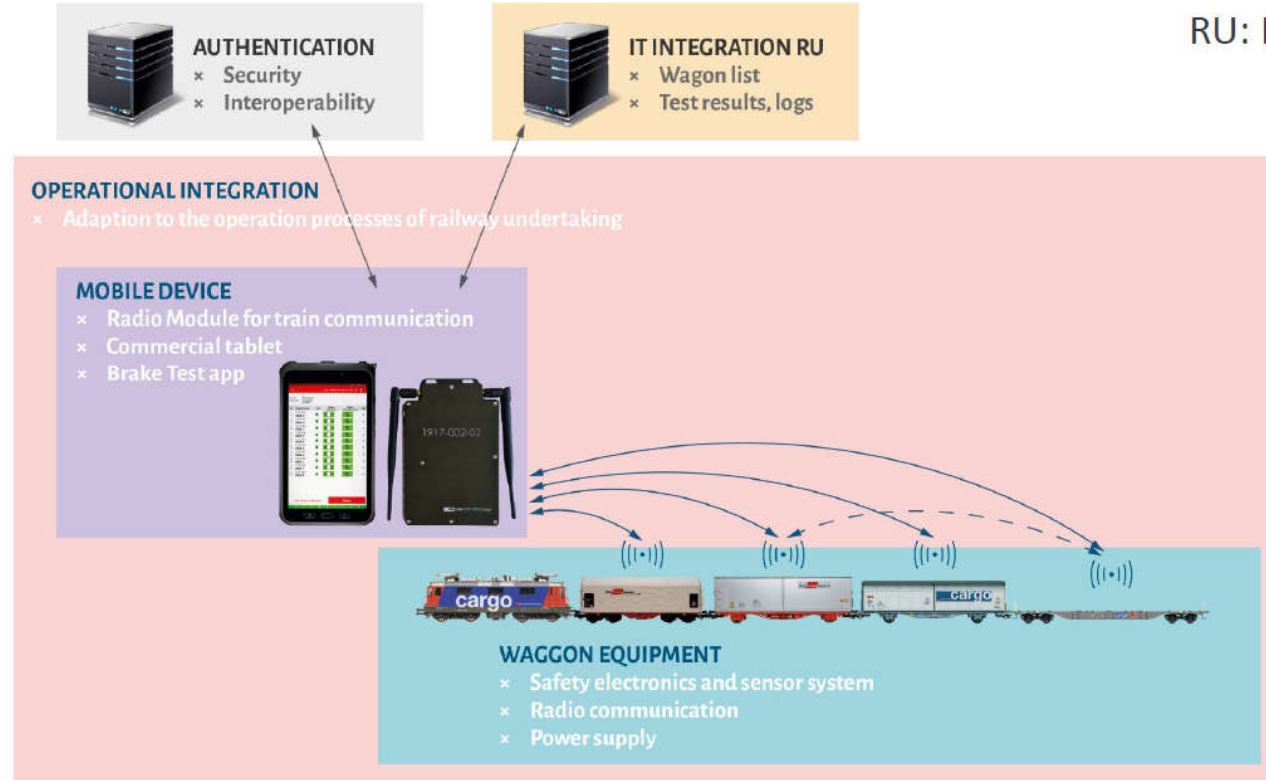

RU: Integration in SMS necessary

Technology

- › SIL 2
- › Open interfaces
- › Secure communication with all equipped waggons (also of different keepers)

PJM as Solution Provider

- › PJM supports the RUs in the integration

Part II, Chapter 3. : Research needs and related ongoing projects

Section 3.2 – rolling stock side brake test and monitoring systems

VTG project A : Double-pocket wagons Sdggmrss TWIN-III

Automated Brake Test – Safety for Process Automation

Safety relevant development

- › according to EN 50126, EN 50129, EN 50657, EN 50159, EN 61508, EN 62061, EN 50155, et al.

Safety relevant system solution

- › SIL2 sensors in combination with safety electronics for safe and reliable status determination
- › Wireless LoRa in train communication system with safe communication protocol
- › Utilization of existing standard tablets for status visualization

Homologation and approval by TÜV Süd Rail

- › WaggonTracker ABP is the first and only approved automated brake test system in Europe

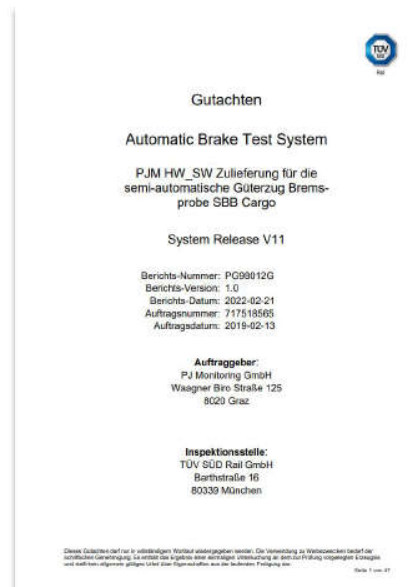

Part II, Chapter 3. : Research needs and related ongoing projects

Section 3.2 – rolling stock side brake test and monitoring systems

VTG project A : Double-pocket wagons Sdggmrss TWIN-III

Schema Sdggmrss(s)

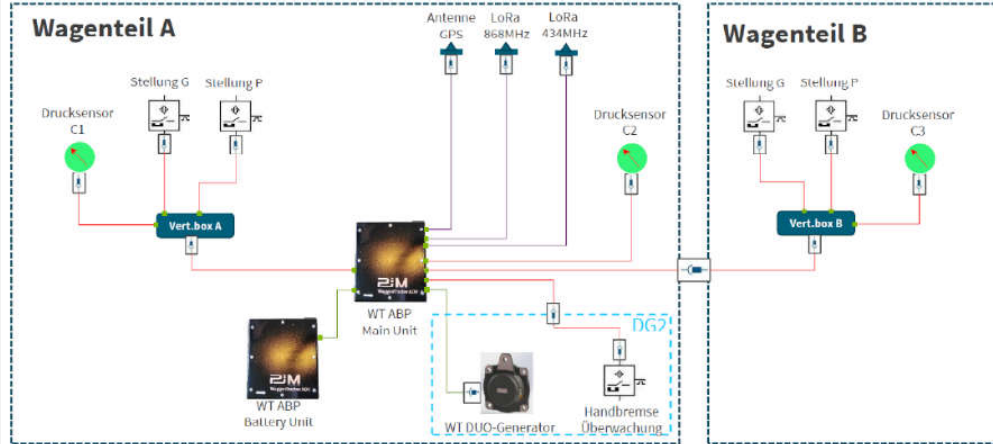

Part II, Chapter 3. : Research needs and related ongoing projects

Section 3.2 – rolling stock side brake test and monitoring systems

VTG project B : Sggn(s) 80' 4-axle container wagons

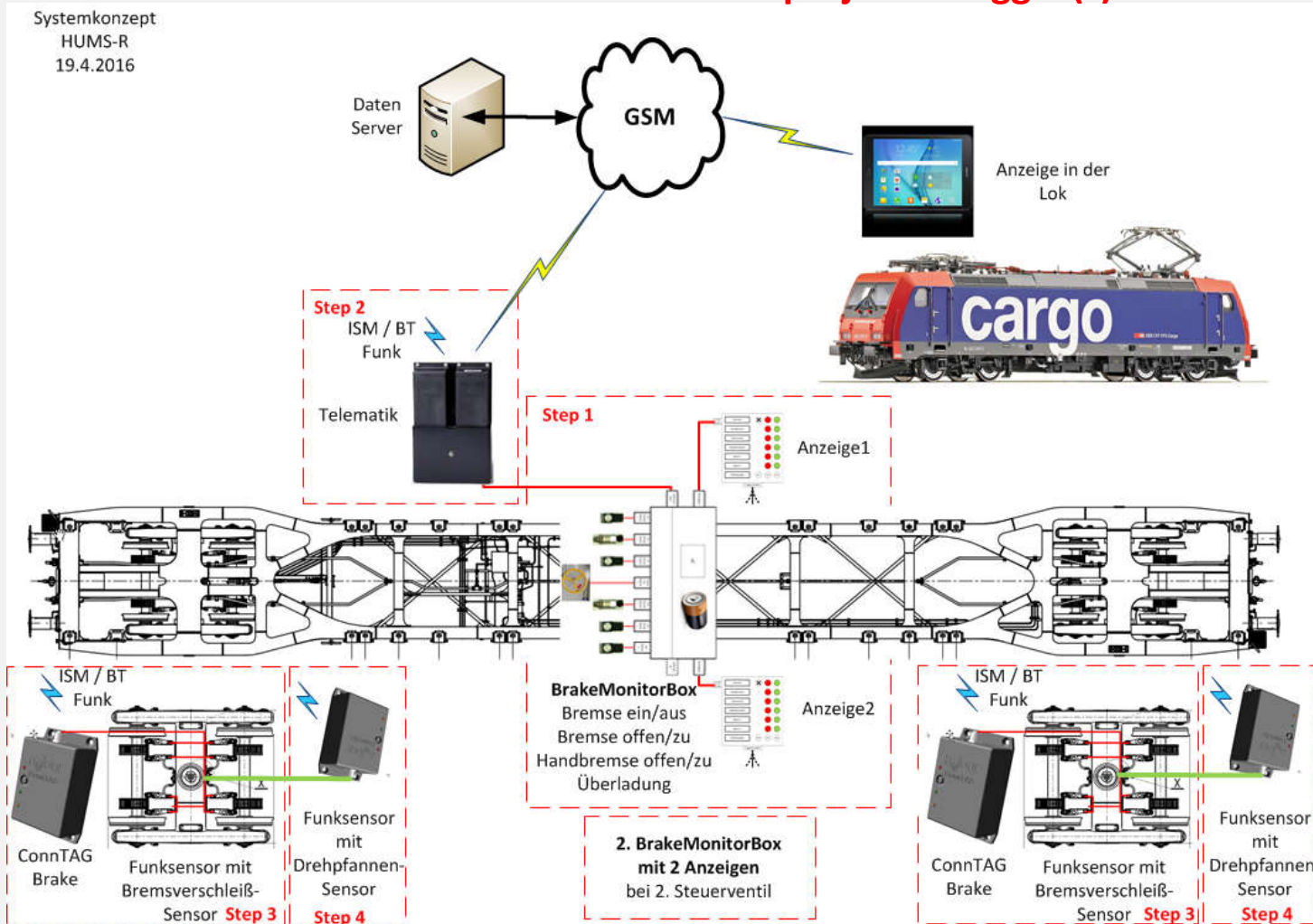

Part II, Chapter 3. : Research needs and related ongoing projects

Section 3.2 – rolling stock side brake test and monitoring systems

VTG project B : Sggn(s) 80' 4-axle container wagons

Info	Function	Sensor	Connection	Communication	Receiver
1x Main pipe pressure	If MPP > 3,5 bar + velocity = 0 (no vibrations detected) = standstill & pressure measurable + release brake → Boot up the System, record the status, send it to the BMS-box Pressure sensor	Drucksensor	2-pole	By wire	BrakeMBox
2 x T pressure	Weight/overloading Pressure sensor	Drucksensor	3-pole	By wire	BrakeMBox
1x R-pressure Pos. 18	If brake lever = „on“ <u>and</u> R-pressure > 0,5 bar, → brake on → otherwise we display an black X (for brake system off) Pressure sensor	Drucksensor	2-pole	By wire	BrakeMBox
2x C-pressure Pos. 19	If pressure > 0,2 Bar , then the brake is applied-> (red light), otherwise the brake is released -> (green light) Pressure sensor	Drucksensor	2-pole	By wire	BrakeMBox
Brake lever on/off	If brake lever = „off“ → brake is off (black cross)	Schaltelement	2-pole	By wire	BrakeMBox
Hand brake sensor	Hand brake (Induktive sensor) completely released / not released	Proximity sensor	2-pole	By wire	BrakeMBox
G/P Sensor	Position of the G/P lever (Induktive sensor)	Schaltelement	2-pole	By wire	BrakeMBox
4 Brake-Pad- Sensoren for up to 3 bogies	2 contacts per pad (at 5mm and 4mm wear) → 5mm prewarning, 4mm warning signal Wire loops	2 wire loops per Pad	3-pole	Wireless	Telematik

Part II, Chapter 3. : Research needs and related ongoing projects

Section 3.2 – rolling stock side brake test and monitoring systems

VTG project B : Sggn(s) 80' 4-axle container wagons



- Per distributor valve one BrakeMonitorBox
- Every status change will be transmitted by the telematics to a central server
- If the main air pipe pressure rises over 3,5 bar, the system will automatically check the status of all connected sensors and reports them to the central server
- Data of sensors connected by wireless systems are transmitted 1x per day. The last data is shown on the display at the side of the wagon.
- Data of sensors connected by wire to the BrakeMonitorBox are transmitted when triggered and actual status shown on the display at the side of the wagon.

Part II, Chapter 3. : Research needs and related ongoing projects

Section 3.2 – rolling stock side brake test and monitoring systems

VTG project B : Sggn(s) 80' 4-axle container wagons

Digital Brake Test

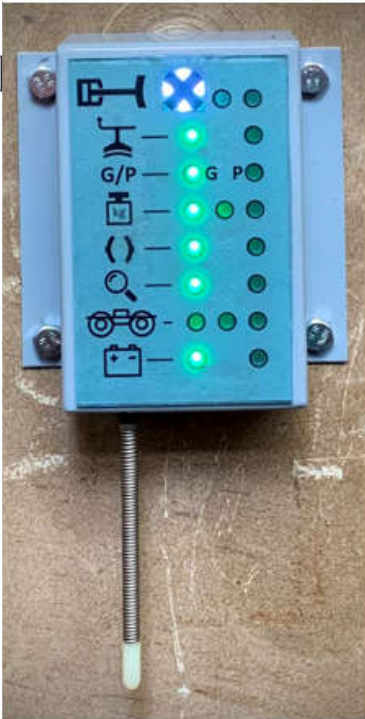
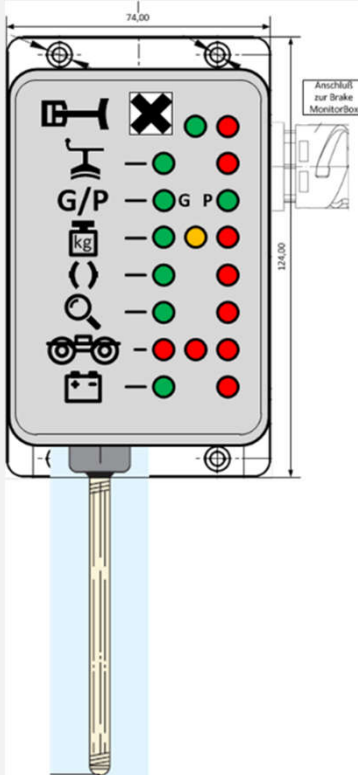

Brake on/off

Handbrake released (green), closed (red)

G/P-lever position

Loading status (empty/loaded/overloaded)

Condition of the Brake pads (ok, worn out)

Centre pivot liner (ok, worn out)

Position of the alert (bogie)

Battery status (charged/empty)



Faster train preparation.

Increased safety.

Digital condition monitoring.

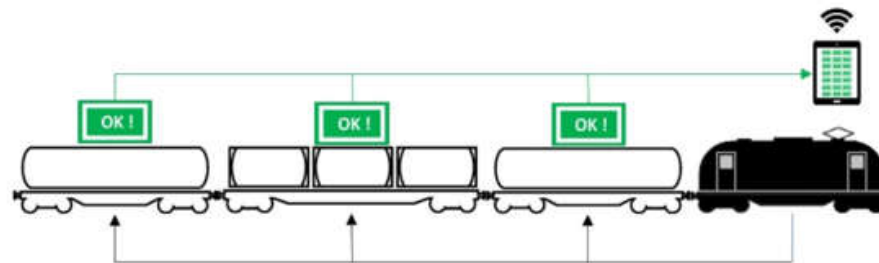

Part II, Chapter 3. : Research needs and related ongoing projects

Section 3.2 – rolling stock side brake test and monitoring systems

VTG project B : Sggn(s) 80' 4-axle container wagons

The BrakeMonitorBox has an IP67 metal box, where the external sensors are plugged in:
 2x T-pressure, 2x C-pressure, R-pressure, main air pipe pressure, sensors: brake on/off, G/P, parking brake on/off The connectors are acc. ISO 15170 / DIN 72585

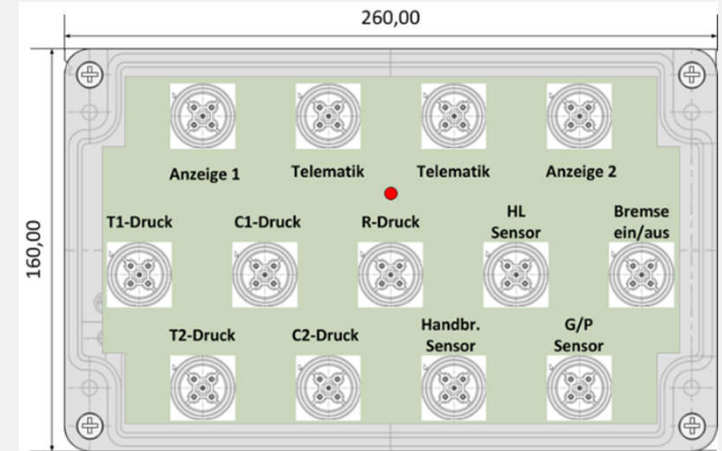

By wireless connection: Check of the brake pads with contact sensors and two stages: Warning message at 6mm and pad change message at 5 mm

Part II, Chapter 3. : Research needs and related ongoing projects

Section 3.2 – rolling stock side brake test and monitoring systems

VTG project B : Sggn(s) 80' 4-axle container wagons

On the locomotive the driver can see the status of the train:

Brake application and release is triggered from the locomotive. However, at the moment this system only works when the train is standing still.

An upgraded version to also monitor the brakes during travelling is not possible with battery powered systems. Other energy supply systems are under investigation.

The screenshot displays the 'asto TELEMATICS' interface for 'alour Online - Objekte Übersicht'. The train number '81375' is entered. The last report was on 23.11.2017 at 15:30. The status bar shows 'Bereit zur Abfahrt' (Ready for departure) with a checkmark. Below this, a row of 16 green icons represents the wagons. A table below provides detailed data for wagons 11 through 15.

PVG Nr.	UIC NR.	Brake Status	G/P	kg	Other Icons	Meldezeit letzte Reihung	Letzte Meldung
11	31-81-128-1-978-3	Green	P	Green	Green	23.11.2017 14:01	23.11.2017 15:13
12	31-81-712-9-008-2	Green	P	Green	Green	23.11.2017 14:03	23.11.2017 15:30
13	31-81-092-5-679-9	Red X	P	Green	Green	23.11.2017 14:05	23.11.2017 15:17
14	31-81-248-1-999-6	Green	P	Green	Green	23.11.2017 14:07	23.11.2017 15:28
15	31-81-281-1-045-3	Green	P	Green	Green	23.11.2017 14:09	23.11.2017 15:21

Buttons: Bremsprobe gestartet, Zustand Zug OK, Alle Bremsen angelegt, Alle Bremsen gelöst, Bereit zur Abfahrt. A 'Bremsprobe abbrechen' button is visible at the bottom.

Part II, Chapter 3. : Research needs and related ongoing projects

Section 3.2 – rolling stock side brake test and monitoring systems

VTG project B : Sggn(s) 80' 4-axle container wagons

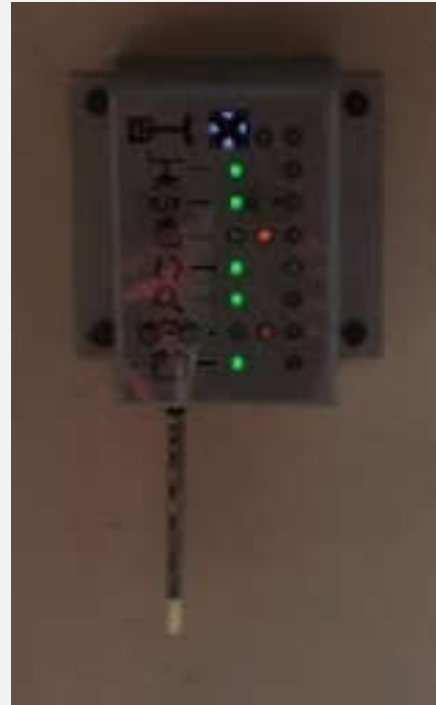

Part II, Chapter 3. : Research needs and related ongoing projects

Section 3.2 – rolling stock side brake test and monitoring systems

Conclusions and next steps

The two projects A and B of slide 92 are examples of what is currently being tested. The involved companies around VTG are investigating the feasibility of possible solutions for rolling stock side brake tests and monitoring systems.

Currently, there are no explicit requirements regarding brake system monitoring.

However, Article 4 of the Railway Safety Directive applies (see slides 23 to 25) which states that RUs and IM shall, based on a risk analysis, identify the needed risk control measures and implement them through their safety management systems (SMS). The risk analysis and the risk control measures shall be monitored and, if required, adjustments shall be made.

Currently, the lack of power supply on wagons poses a burden to further developing technical solutions. However, the introduction of the digital automatic coupler (DAC) is anticipated to solve this.

It is therefore recommended to integrate safety-related rolling stock side monitoring systems, in particular for brake test and monitoring systems, in this project.

Part II, Chapter 3

Research needs and related ongoing projects

Content

Part III, section 3.1: block and wheel behavior in a fixed brake situation

Part III, section 3.2: rolling stock side brake test and monitoring systems

Part III, section 3.3: track-side detection systems

1. Creation of an experts working group:

Considering the whole industry needs.

2. Benchmarking:

Look for the best practices and sharing good (and bad) experiences.

3. Cost Benefits Analysis:

Balance between the safety integrity level and the investments needed.

4. Harmonization:

Publish an International Railways Solution with the methodological approach.

5. Requirements for EU Regulations:

According the EU context, requirements for the Standards TSI Input Plan.

Part II, Chapter 3. : Research needs and related ongoing projects

Section 3.3 – track-side detection systems

Ongoing UIC project “NETWORK MONITOR” - recommendation

- The ongoing UIC Project ‘NETWORK MONITOR’ will address track side Hot Axle Box Detection Systems and Hot Wheel Detection Systems.
 - The outcome of this project may lead to
 - Changes in the INF TSI and the RST TSI;
 - Their application guides;
 - Changes in the OPE TSI;
 - An Acceptable Means of Compliance (AMOC) under the OPE TSI;
 - Changes in existing standards and possible new standards / International Railway Solution (IRS).
- ➔ The Task Force recommends to actively participate in this project to ensure appropriate consideration in legislation and standardization.

Part II, Chapter 4

Impact assessment

- **3 Options** have been considered aligned with the 3 clusters of measures of the final TF Report:
 - Option 0 (baseline) → Risk control measures (UP requirements),
 - Option 1 (including baseline) → Risk control measures (NP) + Changes in legislation/standardization,
 - Option 2 (including Option 1) → Research needs.
- **Key findings:** (see chart on the following slide)
 - Risk control measures (Option 0) improved the situation,
 - Option 1 provides further improvement building on the JNS NP work over short-medium term,
 - Option 2 would deliver additional benefits over the long term.

Part II, Chapter 4. : Impact Assessment

Overall impact

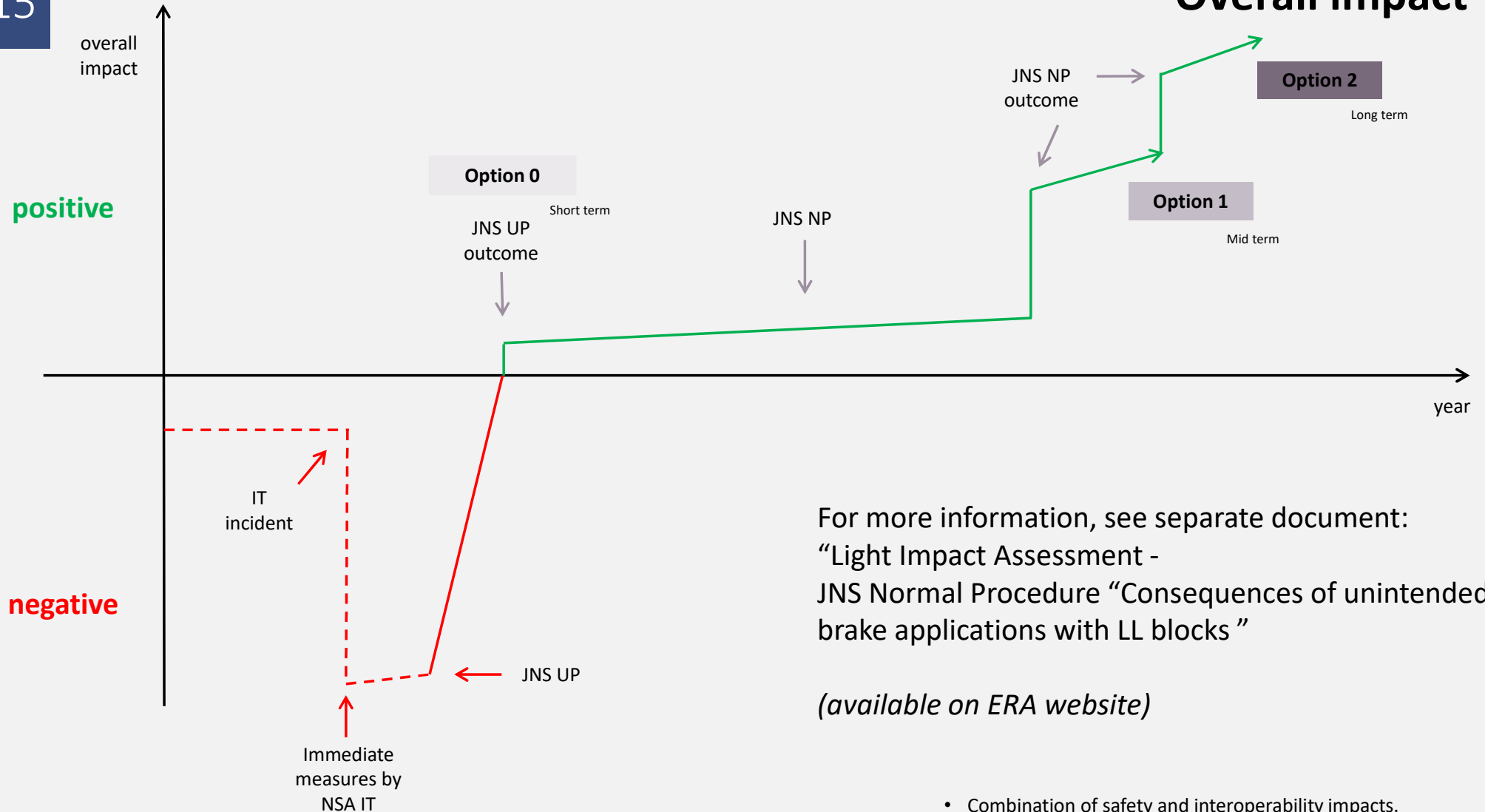

END OF REPORT
