

JNS Urgent Procedure Task Force 2019/01
“Great Belt Accident”

Action Plan

Brussels, 26.04.2019

Background and timeline

- **02/01/2019** at 7:30, a passenger train collided with a semi-trailer from a pocket wagon. The collision occurred on the Great Belt bridge. National Safety Authority Denmark supervised reactions of involved Railway Undertakings and Infrastructure Manager involved. National Investigation Body Denmark started the accident investigations
- **15/02/2019** NSA DK submits urgent procedure notification to JNS Panel
- **28/02/2019** JNS Panel issues an advice to launch a JNS Urgent Procedure
- **13/03/2019** Kick off meeting of the JNS UP task force. Members:
 - National Safety Authorities from Germany, Denmark, Netherlands, Sweden
 - National Investigation Body from Denmark
 - Representative Bodies (see slide 3)
- **27&28/03/2019, 12/04/2019 and 26/04/2019** further task force meetings (see next slides)

Meetings overview

Date	Main topics discussed	Attendance Representative Bodies ¹⁾							
		UIRR	UIP	ERFA	CER	EIM	SAF ²⁾	UIC	UNIFE
13/03/2019 – kick off meeting	<ul style="list-style-type: none"> participants introduction and roles and responsibilities; general understanding accident 	3	2	1	4	3	-	1	-
27&28/03/2019 – first working meeting	<ul style="list-style-type: none"> identification of risks similar occurrences and relevant information establishment of 3 sub groups to prepare draft action plan 	1	2	1	2	3	-	1	-
12/04/2019 – second working meeting	<ul style="list-style-type: none"> discussion of action plan activities and statements from task force members 	1	3	1	4	3	2	1	-
26/04/2019 – concluding meeting	<ul style="list-style-type: none"> finalization of action plan final conclusions and next steps 	1	3	1	2	4	2	1	1

1) https://www.era.europa.eu/agency/stakeholder-relations/representative-bodies_en

2) SAF Holland (manufacturer of hitch type FW6170)

Outcomes of JNS Urgent Procedure

Based on the NIB interim findings, the task force analysed several scenarios and identified the following risk which requires urgent mitigation measures:

Semi-trailers unsecured on pocket wagons with hitch type FW6170 might go outside the gauge during transport

Task force agreed on an action plan (see next pages) which contains short-term risk mitigation measures addressed to RUs, keepers, ECM and terminals.

The actors that carry safety-related responsibilities in the transport of semi-trailers shall evaluate and – if needed – integrate the recommended measures by the JNS UP task force in their safety management system, contracts and instructions.

Final Action Plan - JNS UP task force on the Great Belt Accident

Short term risk mitigation measures for pocket wagons equipped with hitch type FW6170.

When	Who	Action and tools	Consequences	Documentation
0) Maintenance	ECM	All ECMs (note 1) in charge of pocket wagons shall check whether their hitch maintenance (including lubrication (note 2)) intervals related to the king-pin locking match the instruction of the manufacturer and are optimized to the use of the wagons.	Necessary changes identified shall be assessed and implemented without delay.	<p>Conclusions shall be duly justified (based on a risk analysis in accordance with CSM RA) and documented.</p> <p>The next hitch maintenance date shall be indicated on both sides of the pocket wagon (note 4) or shall be made available by the keeper by other means.</p>
1) Optional: At arrival, after removing the semi-trailer or container from the pocket wagon (unloading).	Terminal *	<p>Visual checks in the terminal that...</p> <ul style="list-style-type: none"> I. ...the handles on both sides are in their end position; II. ...the hitch is free of damages, and III. ...the wagon is not marked with a K-label (note 3). <p>Tools:</p> <ul style="list-style-type: none"> - appropriate lighting. - red tape. - K-label (if terminal is contracted by the RU accordingly) 	<p>If any of the checks I., II. or III. returns a negative result</p> <ul style="list-style-type: none"> • red tape shall be affixed on the hitch handles on both sides; • pocket wagon shall not be used for the transport of semi-trailers, and • RU shall be informed. 	<p>Traceability of checks I. to III. shall be assured.</p> <p>Documentation by email from the terminal to the RU.</p>

When	Who	Action and tools	Consequences	Documentation
<p>2) Before placing the semi-trailer on to the pocket wagon (loading)</p>	<p>Terminal *</p>	<p>Checks in the terminal that...:</p> <ul style="list-style-type: none"> a) ...either the hitch maintenance label (note 4) or other means indicate that the date for next periodical maintenance has not expired; b) ...the hitch is free of damages (visually); c) ...all visible moving parts of the hitch are lubricated (visually) as describe in SAF Holland maintenance and operating manual (note 2 contains the relevant excerpt of this manual); d) ...the handles on both sides can be pulled out and released (functional test) (note5); e) ...the handles on both sides cannot be pushed further into the hitch (after they have been released – see previous check d)) (functional test) (note 5); f) ...the “notch” on both sides is not visible (note 6) (visually), and g) ...the hitch height is correctly adjusted to the semi-trailer to be placed on the pocket wagon. <p>Example for checks a) to g) is given in note 5.</p> <p>Tools:</p> <ul style="list-style-type: none"> - appropriate lighting. - hand light. - red tape. - K-label (if terminal is contracted by the RU accordingly) 	<p>If any of the checks a) to g) returns a negative result</p> <ul style="list-style-type: none"> • red tape (terminal) shall be affixed on the hitch handles on both sides; • K label (RU) shall be affixed on both sides of the wagon; • pocket wagon shall not be used for the transport of semi-trailers, and • RU shall be informed. <p>RU after becoming aware of negative results regarding checks a) to g) shall report to the ECM and to the Keeper if required by contract (e.g. GCU Appendix 4).</p>	<p>Traceability of checks a) to g) shall be assured.</p> <p>Documentation by email from the terminal to the RU.</p>

When	Who	Action and tools	Consequences	Documentation
3) During placing the semi-trailer onto the pocket wagon (loading).	Terminal *	<p>A dedicated staff member, standing next to the pocket wagon, shall direct the crane driver or reach stacker operator.</p> <p>Therefore this dedicated staff member, standing next to the pocket wagon, in addition to the crane driver or reach stacker operator shall assure that the kingpin is placed <u>into the guiding ring of the hitch</u> and that there are no gaps between the hitch top plate and the semi-trailer plate (note 7).</p>		
4) Immediately after placing the semi-trailer onto the pocket wagon (loading)	Terminal *	<p>Checks in the terminal that...:</p> <ul style="list-style-type: none"> h) ...the king pin is placed into the guiding ring of the hitch and that there are no gaps between the hitch top plate and the semi-trailer plate (note 7); i) ...the retaining notch of the handle is not visible on the loading side of the wagon (note 6) , and j) ...the king pin locking works correctly, by trying to push the handle back to its end position. <p>Tools:</p> <ul style="list-style-type: none"> - hand light. - red tape. - K-label (if terminal is contracted by the RU accordingly) 	<p>If any of the checks h) to j) returns a negative result</p> <ul style="list-style-type: none"> • red tape (terminal) shall be affixed on the hitch handles on both sides; • K label (RU) shall be affixed on both sides of the wagon; • pocket wagon shall not be used for the transport of semi-trailers, and • RU shall be informed. <p>RU after becoming aware of negative results regarding checks h) to j) shall report to the ECM and to the Keeper if required by contract (e.g. GCU Appendix 4).</p>	<p>Traceability of checks h) to j) shall be assured.</p> <p>Documentation by email from the terminal to the RU.</p>

When	Who	Action and tools	Consequences	Documentation
5) Before train departure	RU	<p>Checks pocket wagons loaded with semi-trailers that...:</p> <ul style="list-style-type: none"> i. ... the check performed by the terminal returned no negative results; ii. ... no hitches are marked with red tape iii. ...no wagons are marked with a K-label (note 3) iv. ...the king-pin is correctly placed and locked, by trying to push the handle back to locked position on both sides of the wagon. v. ...that the retaining notch of the handle is not visible on both sides of the wagon (note 6) <p>Tools:</p> <ul style="list-style-type: none"> - hand light - K-label 	<p>If any of the checks i. to v. returns a negative result...</p> <ul style="list-style-type: none"> • ...the semi-trailer shall be removed from the pocket wagon concerned or if not possible; • ...the pocket wagon concerned shall be shunted out from the train consist; • In both cases, a K Label (note 3) shall be affixed on both sides of the pocket wagon concerned, if not yet present. <p>It is recommended to see also GCU Appendix 9 Annex 1 chapter 6.7. (note 3)</p> <p>The RU shall ensure that all wagons having red tape have a K label affixed on both sides.</p> <p>RU shall report to the ECM and to the Keeper if required by contract (e.g. GCU Appendix 4).</p>	Traceability of checks i. to v. shall be assured.

* A contract between the RU and the terminal operator must be present, if these checks are done by the terminal operator. The checks must be controlled within the scope of the RU's safety management system, especially in regards of procedures to be applied, and qualifications of staff involved.

Note 1: ECM functions and their relations according to:

- 1) Commission Regulation (EU) No 445/2011 of 10 May 2011 on a system of certification of entities in charge of maintenance for freight wagons and amending Regulation (EC) No 653/2007.
- 2) ERA Guide for the application of the Art 14 (a) of the Safety Directive and Commission Regulation (EU) No 445/2011 on a system of certification of entities in charge of maintenance for freight wagons, Document ID: ERA-GUI-100, dated 08.07.2015.

According to Section 4 of the Regulation 445/2011/EU, the maintenance system shall be composed of the following functions:

(a/ aka ECM1) the **management function**, which **supervises** and **coordinates** the maintenance functions referred to in points (b) to (d) and ensures the safe state of the freight wagon in the railway system; The certified ECM is the one who performs this function and is responsible for the others through its SMS.

(b/ aka ECM2) the **maintenance development function**, which is responsible for the management of the maintenance documentation, including the configuration management, based on design and operational data as well as on performance and return on experience;

(c/ aka ECM3) the **fleet maintenance management function**, which manages the freight wagon's removal for maintenance and its return to operation after maintenance; and

(d/ aka ECM4) the **maintenance delivery function**, which delivers the required technical maintenance of a freight wagon or parts of it, including the release to service documentation.

These 3 last functions are integrated in the maintenance system through a MANAGEMENT PROCESS (see the figure to the right).

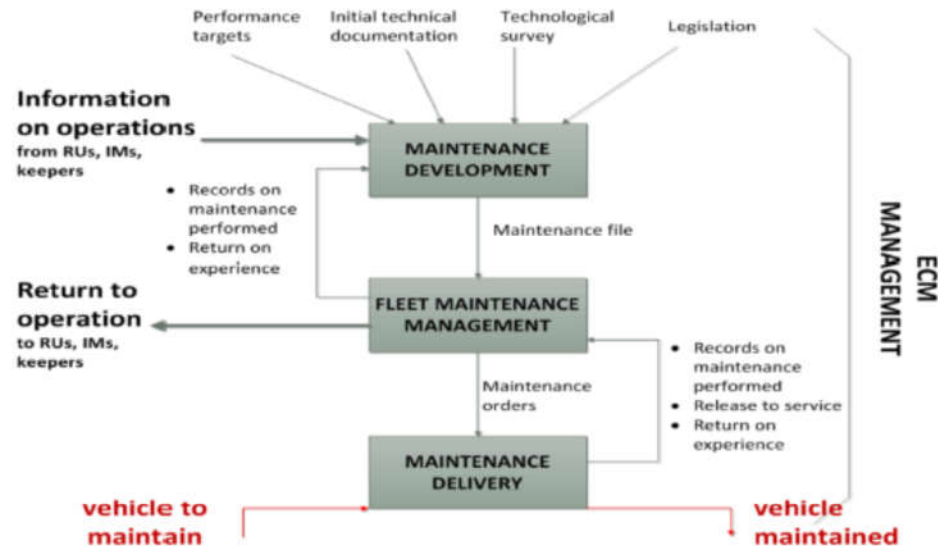

It should not be understood as a strictly mandatory organisational structure for ECMs. Nevertheless the structure put in place by the ECM has to reflect on this functional maintenance breakdown. The ECM has to attach all elements (internal services, subdivisions and contractors) of its organisational structure to one or more maintenance functions.

Note: The ECM4 functions shall be under the control of ECM 1, even if it is outsourced and certified. ECM4 to deliver "records on maintenance performed" to ECM3 who report further to ECM2.

ECM1 is responsible and certified for the entire process

Note 2: Lubrication

Periodic lubrication of the railcar hitch FW6170 is to be conducted at least every four months by using a water resistant, lithium based grease. We recommend a long-term pressure grease NLGI class 21 with MoS₂ or, e.g. MOTOREX. The lubrication intervals must be adapted to the respective operating conditions, shorter and longer intervals are possible. Make sure that all moving parts are clean and adequately lubricated. Attention should be paid especially to the following lubrication points:

1. All parts of the locking mechanism
2. Bevel gear (every 8 months or if required)
3. Spindle
4. Outer surface of the lifting arms
5. Contact surface of sliding frame guide shaft

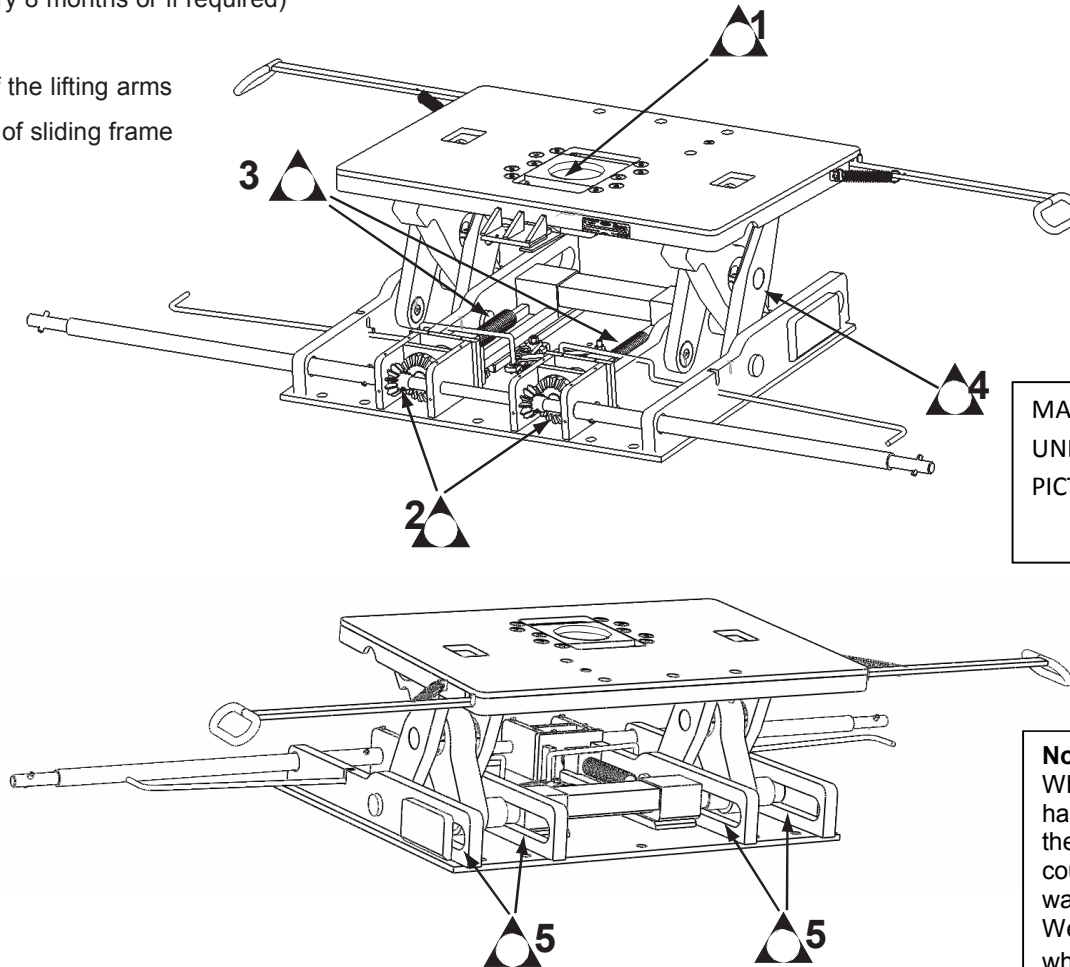

MAKE SURE ALSO LUBRICATE ALL MOVING PARTS UNDER THE HITCH PLATE, NOT SHOWN ON THE PICTURE

Notes:

When cleaning the railcar hitch, environmentally harmful substances may be used. We point out that the corresponding current waste regulations of each country must be observed when disposing of this waste.

We recommend the wearing of protective gloves when working with lubricant.

Note 3: GCU Label K shall be applied to the wagon, indicating that the wagon may not be reloaded:

LABEL K

(RU's symbol)	Wagon Number	Label	
	<input type="text"/> <input type="text"/> <input type="text"/> <input type="text"/> <input type="text"/> <input type="text"/> <input type="text"/> <input type="text"/> <input type="text"/> <input type="text"/> <input type="text"/>	K	
Do not reload / To be repaired following unload-			
1 Running Gear	2 Suspension	3 Brake	4 Wagon under-frame and bogie
5 Buffing and draw gear	6 Wagon body	7 Loads and load units	8 Miscellaneous
<input type="text"/> <input type="text"/> <input type="text"/> <input type="text"/>	<input type="text"/> <input type="text"/> <input type="text"/> <input type="text"/>	<input type="text"/> <input type="text"/> <input type="text"/> <input type="text"/>	<input type="text"/> <input type="text"/> <input type="text"/> <input type="text"/>
Other details			
Stamp of issuing office	Date of stamping	Signature	
For issuing RU's use			

blue, size roughly 148 x 210 mm

K labels serve to indicate that there is a problem with the wagon or load unit, but that these can – for the time being – continue to be operated. However, the problems must be resolved prior to reloading; any reloading of the wagon will lead to its withdrawal.

The defect code must be filled out completely in accordance with GCU Appendix 9, Annex 1:

1. Circle or tick the number of the defect group/category
2. Enter the exact defect number in the empty boxes

K labels are to be affixed to both sides of the wagon in a clearly visible position, close to the label-holder or on the inscription plates. The printed version of the K label must contain the data provided for by this annex.

Component	Code no.	Irregularities/Criteria/Notes	Action to be taken	Category
Gear for securing load units (ILU) on container wagons	6.7			
	6.7.1	Trestle or spigot distorted or defective		
	6.7.1.1	– trestle not in use	K	3
	6.7.1.2	– trestle in use	Rectify +K. If not possible, detach wagon	5
	6.7.1.3	– spigot not in use	K	3
	6.7.1.4	– spigot in use	Rectify +K. If not possible, detach wagon	5
6.7.2	Coupling pin of trailer not locked into trestle	Lock. If not possible, detach wagon	5	

Component	Code no.	Irregularities/Criteria/Notes	Action to be taken	Category
Gear for securing load units (ILU) on container wagons <i>(continued)</i>	6.7.3	Trestle not in use and not locked	Place trestle in its end position and lock. If not possible, secure temporarily + K	3
	6.7.4	Trestle adjustment device unlocked and potentially fouling the gauge	Push in and secure trestle adjustment device. If not possible, detach wagon	5
	6.7.5	Moving parts not properly secured (e.g. retractable spigots, handrails for shunters, etc.)		
	6.7.5.1	No risk of fouling the gauge	Rectify. If not possible, secure provisionally	3
	6.7.5.2	Risk of fouling the gauge	Rectify. If not possible, detach wagon	5
	6.7.6	Anti-crash system of trestle triggered, damaged elements		
	6.7.6.1	– in use	Detach wagon	5
	6.7.6.2	– not in use	K, close emergency stop cock	4

Note 4: Check the hitch maintenance label if present:

It is possible to affix a "Hitch maintenance label" to both sides of the wagon, adjacent to each hitch.

Example by VTG:



Note 5: Example of a procedure for functional (technical) check suggested by VTG:

Functional test for Wagon Hitch FW6170 on Sdggmrs(s)

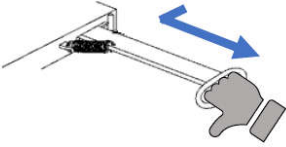
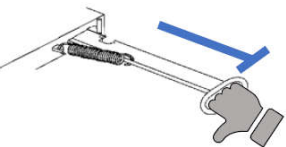
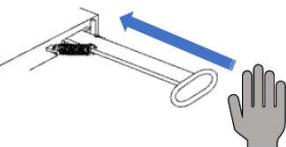

Before Loading

1)	Check when the last maintenance was carried out for the wagon hitch, see period grid at the wagon. Is the interval since the last maintenance exceeded, do not load a trailer on the wagon and inform railway undertaking or VTG accordingly (see keeper contact details at the wagon).
2)	Check the wagon hitch for visual defects or damages. If there are defects or damages do not load a trailer on the wagon and inform VTG accordingly (see keeper contact details at the wagon).
3)	<p>Check the wagon hitch for correct locking function in the cone. The locking bar must be able to be pulled out by the operating handle and after release of the handle be able to be fully pulled back by the springs into the hitch.</p> <p>1 PULL / ZIEHEN</p>  <p>2 HOLD / HALTEN</p>  <p>3 RELEASE / LOSLASSEN</p>  <p>Check that the handle has reached the end position by trying to push the handle further inward</p>

Notes

- 1) See the previous page for an example.
- 2) Visual damages could be e.g. a bent handle or a missing spring.
- 3) Check from both sides: The handle must be easy to pull out, and it must go back to its end position without problems. The retaining notch must not be visible. See note 6.
- 4) It is recommended to lift the hitch during this check, as it is not feasible to inspect under the plate in this position in lower position.

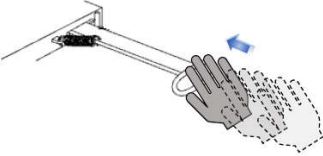
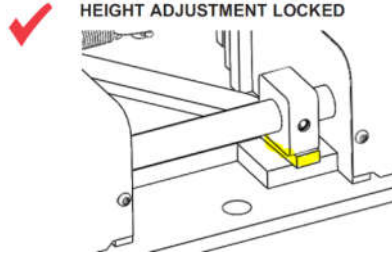
	<p>4 PUSH / NACHSTOSSEN</p>  <p><i>Workshop function: If the handle has not reached the end position by itself, check if dirt or grease hinders the movement or if there is a damage to the locking mechanism.</i></p>
4)	The wagon hitch should be well greased, by all visible moving parts.
5)	<p>The height adjustment of the wagon hitch should be positioned in the desired height for the next loading and must be locked (Indicator fully under the square block - for a detailed description see separate manual).</p> 

Examples of period grids:

Hitch / Stützbock
6 Month / 6M

Sema	01.2019

A B

A = Workshop, shortcut
B= last check

Hitch / Stützbock
4 Month / 4M

Sema	01.2019

A B

A = Workshop, shortcut
B= last check

Note 6: Visually check that the handle is not in its open position

Illustrations

The operating handle shall be retracted and the retaining notch must not be visible.

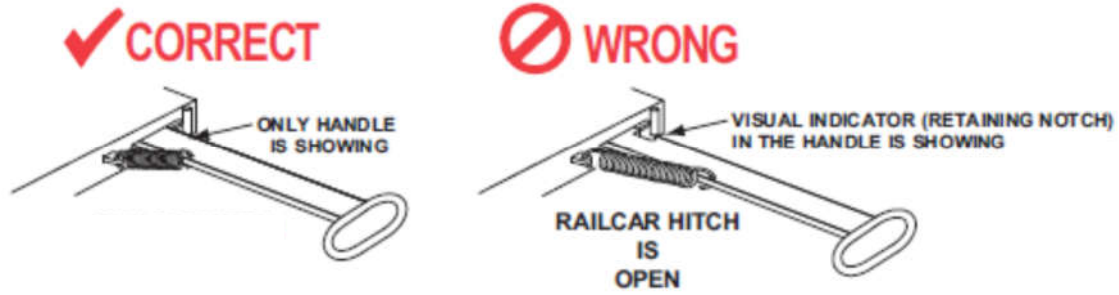

Pictures of a modified handle in open position.



Note 7: Visually check that the semitrailer is loaded correctly and the kingpin is in the right position inserted into the guide ring

- A. The kingpin must be fully inserted into the guide ring and there must be no gaps between the trailer plate and the railcar hitch top plate.

✓ **CORRECT**

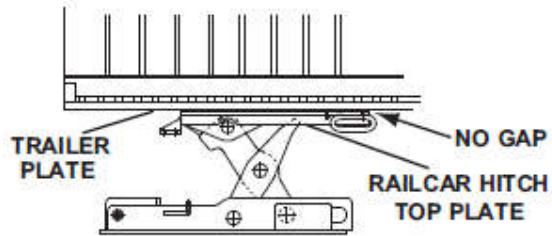

Kingpin is properly engaged.

⊘ **WRONG**

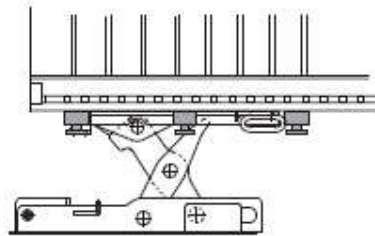

Kingpin is in front of, behind,
or to the side

⊘ **WRONG**

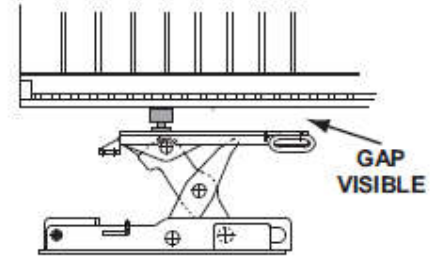

Kingpin is on the top.