



**INTEROPERABILITY UNIT**

**TAP TSI ANNEX B.56  
RU/IM COMMUNICATION APPLICATION GUIDE**

<b>REFERENCE:</b> ERA/TD/2012-11/INT	<b>DOCUMENT TYPE:</b> APPLICATION GUIDE
<b>VERSION:</b> 1.0 FINAL	<b>TAP TSI</b>
<b>DATE:</b> 06.12.2013	

## AMENDMENT RECORD

<b>Version</b>	<b>Date</b>	<b>Section number</b>	<b>Modification/description</b>
1.0 DRAFT	01.08.2012	All	Import from TAP TSI phase 1 delivery
1.0 FINAL	06.12.2013	All	Final publication

## **1 Introduction**

The present document belongs to the set of Technical Documents described in Annex III „List of Technical Documents referenced in this TSI“ of the COMMISSION REGULATION (EU) No 454/2011.

## **2 Updating**

This document is published by the European Railway Agency. Any reader detecting errors or needing clarification should contact the European Railway Agency (TAP\_TSI@era.europa.eu).

Proposals for additions or updates can be sent to the same mail addresses, and will undergo the Change Control Management process described in the TAP regulation.

### **3 Table of Contents**

1	Introduction.....	2
2	Updating.....	3
3	Table of Contents .....	4
4	Management Summary .....	8
5	Who should read what.....	10
Part A - Prerequisites.....		12
6	Background & Purpose of this Implementation Guide .....	12
7	RU/IM Architecture .....	14
8	End-to-End Processes (High level overview of the processes) .....	16
9	Use of identifiers.....	19
	9.1 Overview of the current train identification .....	19
	9.2 Train and Path Identification in Planning IT systems.....	20
	9.2.1 Numbers .....	20
	9.2.2 Commonly Used Systems .....	21
	9.2.3 Without the Commonly Used System .....	21
	9.3 Train and Path Identification in Operations systems .....	22
	9.4 Summary.....	24
10	Reference Data .....	25
	10.1 Reference File Implementation Guidelines.....	25
	10.2 Document Objectives .....	25
	10.3 Location reference file.....	26
	10.4 Regular Maintenance .....	28
	10.4.1 Roles in Regular Operation .....	29
	10.5 Project Actors for Reference Data.....	30
	10.6 Quality Criteria indicators .....	31
	10.7 Data to be held.....	31
	10.7.1 Company Description .....	31
	10.7.2 Country description.....	32
	10.7.3 Location Description .....	33
	10.7.4 Initially population .....	35
	10.7.5 Maintenance Use case .....	35
11	Code Lists.....	37
	11.1 codes.....	37
	11.2 Index of Code lists,.....	39
12	Message Header for RU/IM communication .....	41
	12.1 Explanation of Message Header Elements .....	42
	12.2 Example XML message after processing by the Common Interface .....	44
	12.3 Further explanation on Message Identifiers .....	44
	12.4 Payload of the Messages .....	45
Part B - Planning of Trains.....		46
13	Short Term Path Request.....	46
	13.1 Introduction .....	46
	13.1.1 Long-Term Planning linked with Short-Term Planning.....	46
	13.1.2 The need for Harmonisation .....	46
	13.1.3 Support Mechanism for Harmonization.....	47
	13.2 Assumptions.....	47
	13.3 Explanation on the involvement of the RUs and IMs.....	48

# European Railway Agency

## ERA/TD/2012-11/INT Annex B.56 of TAP TSI

---

13.4	Summary of the outputs .....	49
13.5	Processes .....	51
13.5.1	High Level Overview of the Process .....	51
13.6	The need for Full and Partial Harmonization .....	54
13.7	Path Request Scenarios.....	55
13.8	Short Term Path Request process .....	56
13.8.1	Process “Short Term Path Request” .....	56
13.8.2	Process “Short Term Path Request – Full Harmonization” .....	57
13.8.3	Process «Short-Term Path Request partial harmonisation» .....	57
13.8.4	Process «Path cancellation by RU».....	57
13.8.5	Process «Path alteration by IM» .....	58
13.8.6	Process «Path modification by RU>> .....	58
13.8.7	Process «Utilisation Notification by RU».....	59
13.8.8	The Need for Path Studies .....	59
13.9	Train Identifiers .....	60
13.9.1	Identification of the train.....	60
13.9.2	Related Trains as Part of Train Identification Section .....	60
13.9.3	Related Trains as Part of Train Activity.....	61
13.10	Messages for Short Term Path Request .....	61
13.10.1	General remarks to all Messages .....	61
13.10.2	Structure of the Message.....	62
13.10.3	Message ‘Path Request’ .....	64
13.10.4	Message ‘Path Details’ .....	64
13.10.5	Message ‘Path Confirmed’.....	64
13.10.6	Message ‘Path Details Refused’ .....	65
13.10.7	Message ‘Path Cancelled’ .....	65
13.10.8	Message ‘Path Not Available’ .....	65
13.10.9	Message ‘Dossier’ (Dossier Location and Dossier Section) .....	65
13.10.10	Message ‘Answer Not Possible’ .....	65
13.10.11	Message ‘Utilisation notification’ .....	66
13.10.12	Message ‘Receipt Confirmation’ .....	66
13.11	Elements specific to stakeholders .....	66
13.12	Business Scenarios.....	66
13.12.1	Ordinary train running across two IMs networks.....	68
13.12.2	Ordinary train running across two networks.....	70
13.12.3	Splitting of a train .....	72
13.12.4	Attaching of a train to another train.....	74
13.12.5	Trains with different routes on specific days .....	76
13.12.6	Change of a booked train for certain days (e.g. planned re-routing).....	78
13.12.7	Trains with Through Coaches.....	80
13.12.8	Trains that cannot leave before another train has arrived (diagram dependence) .....	82
13.12.9	Trains that need to be shunted from one platform to another at a location during the train run .....	84
13.13	Business rules .....	86
13.13.1	Train Weight/Train Length .....	86
13.13.2	Loco Type Number .....	87
13.13.3	Combined Traffic Load Profile .....	87
13.13.4	Highest planned speed and minimum break weight percentage .....	87

# European Railway Agency

## ERA/TD/2012-11/INT Annex B.56 of TAP TSI

---

13.13.5	Braking weight and Minimum Brake Weight Percentage .....	88
13.13.6	Use of the Train Activity Type and Associated Trains .....	88
13.13.7	Timing at location .....	88
13.13.8	Dwell Time .....	89
13.13.9	Received on Time .....	89
13.13.10	Status of RU/IM harmonization .....	89
13.13.11	Use of Affected Section .....	90
13.13.12	Network Specific Parameters .....	90
13.13.13	Contact Detail .....	90
13.13.14	Path Dossier Error .....	91
13.13.15	Type of Request .....	91
13.14	Application of the Calendar in the Message .....	93
13.14.1	Overview of the Calendar .....	93
13.14.2	Preconditions for the use of the calendar .....	94
13.14.3	Calendar used in section related Messages .....	96
13.14.4	The Elements of a calendar .....	96
13.14.5	Rules related to the Calendar Element .....	96
13.14.6	Using the calendar element .....	97
13.14.7	Application of the Calendar at the reference location .....	98
13.14.8	Application of the Calendar in the Affected Section .....	101
13.15	Handling of Handover in Border Sections .....	102
Part C	Operation of Trains .....	104
14	Train Preparation .....	104
14.1	Process triggering the Train Ready message .....	105
14.2	Content of the message .....	108
15	Train Running Information and Forecast .....	110
15.1	Process triggering the Train Running Information message .....	110
15.2	Process triggering the Train Running Forecast message .....	111
15.3	Information to the Station Manager .....	112
15.4	Content of the messages .....	113
16	Service Disruption/Train Running Interrupted .....	114
16.1	Process triggering the message .....	114
16.2	Information to the Station Manager .....	115
16.3	Information storage .....	115
16.4	Content of the message .....	116
17	Change of Track/Platform .....	117
17.1	Process triggering the message .....	117
17.2	Content of the message .....	117
18	Train Journey Modified .....	119
18.1	Requirements on messaging .....	119
18.2	Process triggering Journey Modified message .....	119
18.3	Change of Train Number (OTN) .....	120
18.4	Content of the Message .....	120
19	Delay Cause .....	122
19.1	IM informs the RU on the delay cause .....	122
19.2	RU informs the IM on the Delay Cause .....	124
19.3	RU informs the IM about restrictions .....	124
19.4	Information to the Station Manager .....	124
19.5	Content of the message .....	124

# European Railway Agency

ERA/TD/2012-11/INT Annex B.56 of TAP TSI

---

20	Passengers information in station area and vehicle area .....	125
20.1	Passengers information in station area .....	125
20.2	Passengers information in vehicle area.....	125
21	Train Location.....	126
21.1	Train Location Process description .....	126
21.2	Train Location Messages .....	126
21.2.1	Enquiry about Train Running Information .....	126
21.2.2	Enquiry about Train Running Forecast .....	127
21.2.3	Enquiry about Train Delay Performance.....	127
21.2.4	Train Delay Performance.....	127
21.2.5	Enquiry about Train Forecast At Reporting Location .....	128
21.2.6	Train Forecast at Reporting Location.....	129
21.2.7	Answer not possible or inadmissible.....	129
Part D - Overall requirements .....		130
22	General remarks.....	130
22.1	Use of Train Number and Train Identifiers .....	130
22.2	Explication of difference between train and path.....	130
22.3	Use of common elements in the messages.....	131
22.4	Mandatory or Optional Elements in the Messages.....	131
22.5	Message exchange partners .....	132
22.6	Masterplan for central functions .....	132
23	Data quality.....	133
24	Functional Governance .....	135
24.1	Code allocation .....	135
24.2	Change of messages and/or the structure of the reference file:.....	136
24.3	Allocation of certificates for messages .....	136
24.4	Access to reference data.....	137
24.5	Contact data .....	137
25	Glossary .....	138
26	List of Appendices .....	139



## 4 Management Summary

This document is targeted to those people within railway companies and their suppliers, who are in charge of organising, supervising and/or carrying out the implementation of the TAP and/or TAF RU/IM Communication within their company.

This document explains the TAP and TAF messages derived from both regulations<sup>1</sup>, giving a hint on their legal status, explains their usage; the overall architecture, the establishment and use of the reference data and relevant code list.

The document covers the RU/IM communication of both TAF<sup>2</sup> and TAP. Some parts are specific to one of the TSIs only and are marked accordingly. The relevant TSI for passenger Railway Undertakings (RU), Infrastructure Managers (IM) and Station Managers (SM) is TAP TSI. The relevant TSI for freight RUs and IMs is TAF TSI.

This document covers the use of Messages valid for both TSIs unless stated otherwise for

	Both TAP and TAP	TAP only	TAF only
Short Term Path Requests (Path Request, Path Details, Path Not Available, Path Confirmation, Path Cancellation, Path Details Refused, Path Utilisation Notification, Receipt Confirmation and the not legally imposed Dossier Messages)	X		
Train preparation <ul style="list-style-type: none"> <li>• (Train Composition, Train Accepted, Train Not Suitable, Train Position, Train At Start)</li> <li>• (Train Ready)</li> <li>• (Train Not Ready [TAP only])</li> </ul>	X	X	X
Train Running (Information, Forecast and Delay Cause)	X		
Service Disruption	X		
Change of Track/Platform		X	
Train Location (Enquiries and Responses)			X

Each relevant chapter describes if the message is required by TAP, TAF, both or if it is a supporting proposal outside the legal requirements.

Related reference data on locations and companies as well as code lists are explained as well.

<sup>1</sup> Based in particular on TAP ERA Technical Document B.30 and TAF ERA Technical Document Appendix F.

<sup>2</sup> Messages specific to RU/IM communication (relevant only to TAF TSI, e.g. wagon order, wagon movement etc) are consequently not covered in this document

## **European Railway Agency**

ERA/TD/2012-11/INT Annex B.56 of TAP TSI

---

This document does not cover any requirement on how company internal applications have to be designed or how communication within companies is done. This is up to every company itself.

The document does not cover any Retail specifications derived from TAP TSI.

Apart from the central reference files, this document is not describing specific applications, as neither TAF nor TAP require the use of a specific commercial product.

## 5 Who should read what

This chapter provides a non-legally binding guideline to the reader of which parts to read.

... should read Chapters...	Readers charged with the task of implementing...			
	<b>Train Preparation</b>  relevant for RUs and IMs	<b>Train Running<sup>3</sup></b> (covering real time data exchange)  relevant for RUs, IMs and SMs	<b>Path requests</b> (requesting and attributing paths) relevant for RUs and IMs	<b>Reference data</b>  relevant for RUs, IMs and SMs
<b>Part A</b>				
5	X	X	X	X
6	X	X	X	X
7	X	X	X	X
8	X	X	X	
9	X	X	X	X
10		X	X	X
11	X	X	X	X
<b>Part B</b>				
12			X	<i>to facilitate the use of reference data, reading one of these chapters is recommended as well</i>
<b>Part C</b>				
13	X			
14		X		
15		X		
16		X (TAP only)		
17		X (TAP only)		
18	X	X		
19		X (TAP only)		
20		X (TAF only)		
<b>Part D</b>				
21	X	X	X	X
22	X	X	X	X
23	X	X	X	X
24	X	X	X	X
25	X	X	X	X

<sup>3</sup> Train Running covers the running information, forecast, service disruption, change of track, journey modified, delay cause, information in station and vehicles and train location

# European Railway Agency

ERA/TD/2012-11/INT Annex B.56 of TAP TSI

---

This document covers the implementation of the RU/IM Communication of TAP TSI and TAF TSI. Normally, explanations given are valid for both TSIs (and hence the passenger and freight sector).

- TAP TSI is relevant for passenger Railway Undertakings (RU), Infrastructure Managers (IM) on whose networks passenger train services can be performed and Station Managers (SM). Companies dealing with the implementation of TAP should read all common parts valid for both TSIs and the specific TAP only sections.
- TAF TSI is relevant for freight RUs and IMs on whose networks freight train services can be performed. Companies dealing with the implementation of TAF should read all common parts valid for both TSIs and the specific TAF only sections.

The following applies in this document to distinguish between common information and content valid for one TSI only.

This sentence is valid for both TSIs.

<b>TAP TSI only</b>	<b>TAF TSI only</b>
The section hereunder is relevant for TAP TSI only and has no impact on TAF.	This section hereunder is relevant for TAF TSI only and has no impact on TAP.
<b>This sentence is valid for the implementation of TAP only.</b>	<b>This sentence is valid for the implementation of TAF only.</b>

## **Part A - Prerequisites**

### **6 Background & Purpose of this Implementation Guide**

The TAP and TAF TSI operational part describes the communication between Railway Undertaking (RU), Station Manager (SM) and Infrastructure Manager (IM). In addition to data exchange, the TAF TSI describes business processes for operational interoperability.

The purpose of these standards is to allow railway companies - in the same way for domestic and interoperable<sup>4</sup> services – to

- order train paths
- control and manage their train services (and indirectly staff and fleet)
- Improve customer information provided by RUs and SMs<sup>5</sup>

The implementation of TAF and TAP TSI is one step towards interoperability. Full interoperability requires further steps besides TAF and TAP, as e.g. different operational rules and organisational set ups are valid in the different Member States, requiring different use of these messages. Gradually, these rules should be aligned.

Various requirements in the Passenger Rights Regulation (PRR) and TAP TSI are the basis for these RU/ IM communications. For example Annex II Part II of PRR requires passenger RUs to inform their customers about delays and main connecting services during their train ride. Basic Parameter (BP) 4.2.12 of TAP TSI requires SMs to inform passengers about material delays, change of track or platforms, full or partial cancellation of trains and train rerouting. In order to give this information, data exchange between IMs, RUs and SMs is needed, covered by B.30 of TAP TSI. The supporting processes of ordering train paths and informing the IM about the readiness of a train are covered as well, facilitating the interoperable train run for RUs.

There are common functions for planning and operations that are cited in both regulations and are common or similar to both TAP and TAF stakeholders. These functions are:

#### Common System Components:

- Common Interface (TAP BP 4.2.21; TAF BP 4.2.14)
- Reference Files (TAP BP 4.2.19; TAF BP 4.2.12)

#### Common/similar Messages:

- Train Running Information (TAP BP 4.2.15; TAF BP 4.2.4)
- Train Running Forecast (TAP BP 4.2.15; TAF BP 4.2.4)
- Service Disruption (TAP BP 4.2.16; TAF BP 4.2.5)
- Train Preparation (TAP BP 4.2.14; TAF BP 4.2.3)
- Adhoc Path Request<sup>6</sup> (TAP BP 4.2.17; TAF BP 4.2.2)

---

<sup>4</sup> For RU/IM an “interoperable” train service is understood as a train that involves more than one IM and/or more than one RU.

<sup>5</sup> And IMs, in case they provide services as a station manager or in direct communication to passengers.

Specific to TAF are enquiries about a train and certain parts of train preparation<sup>7</sup>. Specific to TAP are messages intended for customer information.

The application of the Common System Components should be used by both TAF and TAP communities for the operational RU/IM communications. Therefore the related standards and specifications are being aligned.

The Common Messages are based on operational business communications that are also common to the TAF and TAP communities. These operational messages are contained in the message catalogue and have been aligned between TAF and TAP working groups so that they include certain functionality needed in the Passenger and Freight domains.

This implementation guide provides the necessary information to stakeholders of both TAF and TAP to assist in the implementation of the RU/IM functions of both TSIs. The document integrates all parts relevant from the RU/IM part of both regulations in one single guide. It covers prerequisites, such as reference data, the planning part, the operational part and general requirements, e.g. on data quality. Where necessary the document refers to further specifications relevant for the use of the message exchange and described elsewhere. It has to be assured that these referenced documents relevant for implementation are accessible to all stakeholders in a fair and transparent manner. This document also shows the remaining differences between freight and passenger specific processes and/or data according to business needs.

---

<sup>6</sup> Also known as Short Term Path Request (STPR)

<sup>7</sup> The Infrastructure Restriction Notice database is specific to TAF and not covered in this document

## 7 RU/IM Architecture

The following graph shows the general architecture of the RU/ IM communication.

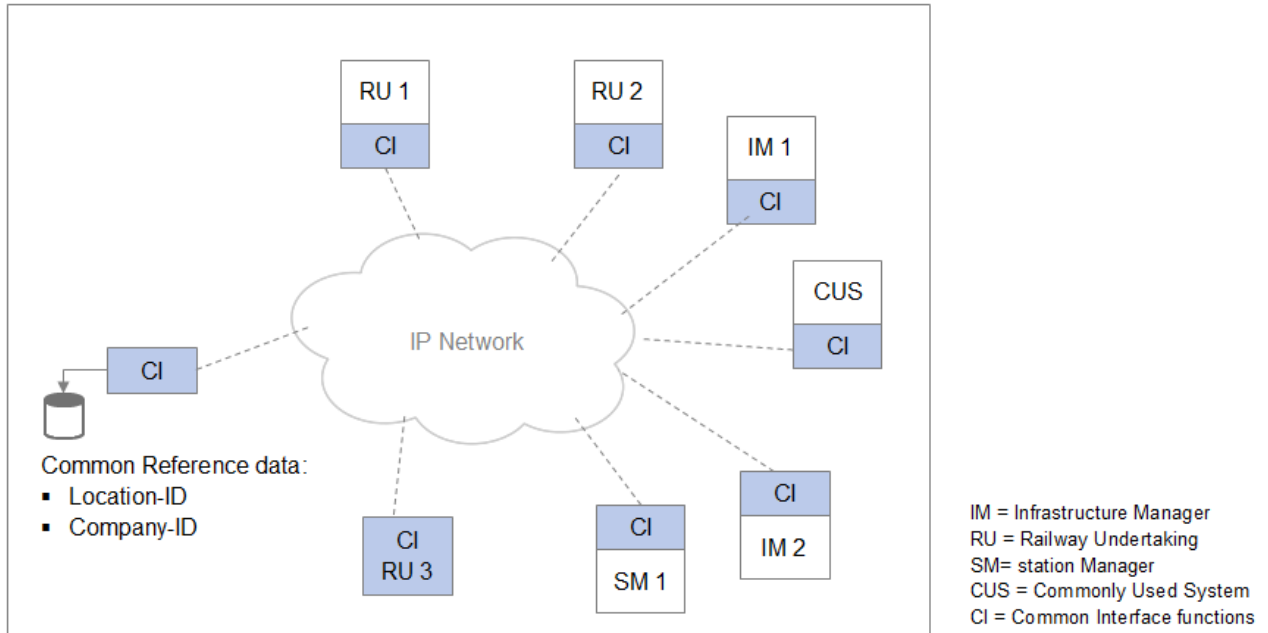

Companies' legacy systems will be linked via an open network<sup>8</sup> (the use of private networks is possible, too), using a common interface (CI). The Common Interface describes a set of functions that are legally required in order to take part in the RU/IM communication.

According to TAP TSI these are:

- message formatting of outgoing messages according to the metadata,
- signing and encryption of outgoing messages,
- addressing of outgoing messages,
- authenticity verification of incoming messages,
- decryption of incoming messages,
- conformity checks of incoming messages according to the metadata,
- handling the single common access to the various databases.

This list is not exhaustive.

The solution to cover the functions of the common interface used by a company can be either a commonly built CI<sup>9</sup> or another development with the required functions. In case a company (in the picture: RU 3) develops and builds new applications, the message exchange can directly be according to TAP and TAF TSI, with no additional application (separate interface) needed. The required functions of the Common Interface (as described above) will have to be covered by this application directly. (In case the new

<sup>8</sup> Any application commonly used by some parties can also be linked (marked CUS in the image). A CUS can be a system that is used on agreement by more than one party to commonly address data exchange according to or additional to TAP and TAF TSI. CUS are not a requirement from TAF nor TAP TSI.

<sup>9</sup> e.g. the CI from the Common Components Groups ("CCG CI")

## European Railway Agency

ERA/TD/2012-11/INT Annex B.56 of TAP TSI

---

application does not support TAP and TAF messages and/or the functions of a CI, a common interface is still needed.)

A company's CI will have to be in accordance with the external interface specification, describing the communication between CIs. That external interface specification of the reference implementation can be found on [[http to be incorporated once available by CCG](#)].

Common reference data (as described in chapter 10) including location codes, company codes and country codes are stored centrally, with different possibilities to access them (e.g. messages, bulk data load, web interface). RUs and IMs will need to have a current subscription to the TAP/TAF governance entity to be given access rights to the reference data service.

Common code lists are enumerated values that are available to be used within the RU/IM messages. These codes are to be used unless a bilateral agreement exists between partners to use other codes. These common Code Lists are published centrally by the governance entity.

Reference data and code lists are mirrored in the companies' systems (see chapter 10.3 for ways to access the data), i.e. each actor holds a copy of the reference data in its own system environment.

The exchange of bilateral and multilateral agreed messages remains possible as well. This covers the use of both messages and codes in the TAP and TAF messages.



## **8 End-to-End Processes (High level overview of the processes)**

This chapter provides an overview on the main end-to-end process covering planning and operations. The details or any other associated processes (e.g. path cancellation) can be found in the individual chapters (in particular 13, 14, 15, 16).

### **Different action of Lead RU / Access Party**

<p align="center">TAP TSI only The section hereunder is relevant for TAP TSI only and has no impact on TAF.</p>	<p align="center">TAF TSI only This section hereunder is relevant for TAF TSI only and has no impact on TAP.</p>
<p>For passenger, a RU or Access Party can be in charge of the coordination between different RUs. This is a RU/AP chosen by the applicant group (the involved RUs) to initiate the dossier. Consequently in this document, the term “Lead RU” is used to designate this RU/AP. The task of the Lead RU/AP in passenger business is limited to the planning unless agreed otherwise by the RUs involved.</p>	<p>For freight purposes the LRU (Lead RU) – if defined – takes complete responsibility of the whole traffic (e.g. only point of contact to freight customer) whereas for passenger purposes the LRU coordinates with other RUs involved in the journey but does not necessarily take the complete responsibility. Messages that are exchanged according to TAF are (also) received by the Lead RU.</p>

### **Main flow (planning)**

RU find demand for a train services (same for passenger and freight), or customer makes requests for a service.

RU does its own planning for this service. If needed, the RU aligns this planning with partner RUs (“RU harmonisation”).

RU makes a request to IM(s) for a train path for either overall journey or a section of the journey.

The possibility exists for IMs to coordinate the different sections of the journey (“IM harmonisation”).

IM offers the path section or journey back to the RU.

RU confirms or negotiates with the IM if changes are required until an agreement is reached between RU and IM (this could be for the whole journey or just a section).

Upon agreement the IM confirms the path in its system (booked train).

The booked train is confirmed in the RUs system for production and also in the RUs system for commercial information.

<p align="center">TAP TSI only The section hereunder is relevant for TAP TSI only and has no impact on TAF.</p>	<p align="center">TAF TSI only This section hereunder is relevant for TAF TSI only and has no impact on TAP.</p>
<p>This might involve publishing the train in the commercial timetable, making the service available for e.g. booking, reservations, publishing the timetable in stations etc. Related processes and standards are</p>	<p>This might involve publishing the train in the timetable and offers for freight forwarders.</p>

## European Railway Agency

ERA/TD/2012-11/INT Annex B.56 of TAP TSI

related to the Retail part of TAP TSI and can be found in the dedicated retail Implementation Guides.	
---	--

The data and identifiers agreed in planning have to be transferred into operations.

### Main flow (operations)

TAP TSI only The section hereunder is relevant for TAP TSI only and has no impact on TAF.	TAF TSI only This section hereunder is relevant for TAF TSI only and has no impact on TAP.
[Not applicable.]	In TAF, the process of sending the train composition from RU to IM and its validation by IM may be required (depending on contractual agreements between IM and RU or according to national rules).

Before the train starts operating the RU informs the IM on the readiness of the booked train to access the network.

The train starts running and train running information is sent from IM to RU at agreed reporting points. Forecasts are sent from IM to RU and also to neighbouring IM involved for agreed forecast points, which could also be before the train starts running.

TAP TSI only The section hereunder is relevant for TAP TSI only and has no impact on TAF.	TAF TSI only This section hereunder is relevant for TAF TSI only and has no impact on TAP.
For TAP, the train running information and forecast are also forwarded to Station Managers. In case a train will not arrive on the scheduled track/platform to allow passengers to alight or leave the train, the information of change of track is issued to the SM (to inform the passengers in the station).	In TAF it is possible for the contracted RU to enquire these messages from the IM.

In case the train running is interrupted with no forecast possible, the IM informs the RU on the train running interruption. Communication (not TAP/TAF message supported) between RU and IM takes place to agree on the continuation of the train.

TAP TSI only The section hereunder is relevant for TAP TSI only and has no impact on TAF.	TAF TSI only This section hereunder is relevant for TAF TSI only and has no impact on TAP.
If the agreed continuation of the train involves a re-routing, cancellation, partial cancellation, stop cancellation or adding stops, train journey modification information is issued by IM or RU to the	[Not applicable.]

## European Railway Agency

ERA/TD/2012-11/INT Annex B.56 of TAP TSI

<p>SM. National rules specify if and how the messages are transmitted between IM, RU and SM.</p>	
--	--

Delay cause messages are used to identify the cause of every single delay affecting the train run.

<b>TAP TSI only</b> The section hereunder is relevant for TAP TSI only and has no impact on TAF.	<b>TAF TSI only</b> This section hereunder is relevant for TAF TSI only and has no impact on TAP.
The train running information and delay causes are used for passenger information, passenger rights handling and performance regimes.	The delay causes are used to inform the customer and for performance analysis.

## 9 Use of identifiers

This chapter provides guidance on the use of identifiers in the RU/IM messages.

As a general principle, sender and receiver of the messages have to agree and know on the scenario they use (e.g. with existing IDs, use of TrainID).

With the full implementation of TAF and TAP, all messages are used with the identifiers (Train ID, Path ID, Path Request ID, Case Reference ID; usually commonly referred to as Train ID or TrID) specified in a separate handbook publicly available at [http://www.uic.org/IMG/pdf/111122\\_wg\\_10\\_handbook\\_final.pdf](http://www.uic.org/IMG/pdf/111122_wg_10_handbook_final.pdf)

The migration from existing IDs to the Train ID has not been developed yet.

Before the implementation of these TAF/TAP identifiers, possibilities exist to use the messages with other existing identifiers. The implementation of TrainID is not required for the deployment of TAP and TAF. The use of existing identifiers is possible in the existing TAF and TAP data catalogues.

The guidelines in this chapter are based on the principles usually applied in national planning and traffic management tools. For some European countries, it is based on existing standards and systems<sup>10</sup>. The RU/IM message structure allows the use of the existing identifiers.

That's why this chapter provides non-binding guidelines on the use of TAP and TAF messages before the implementation of Train ID; details and decisions have to be specified in Network Statements or bilateral agreements.

With the full implementation of Train ID, guidelines are described in the handbook referenced above, completed by further work to be undertaken to define technical matters and close open points.

### 9.1 Overview of the current train identification

Today, a train is identified by its Train Number granted according to:

- UIC leaflets 419-1 and 419-2 for international trains;
- bilateral agreements for some cross-border trains not numbered according to UIC leaflets (e.g. regional cross-border trains);
- national rules for domestic trains<sup>11</sup>.

Note that OPE TSI<sup>12</sup> uses the wording of Operational Train Number (OTN) or Train Running Number (RTN) instead of Train Number. In this chapter the wording of Train Number is used.

The actual principles are:

- a path is requested by the RU to the IM for the train the RU intends to run (for international train, a path section is requested to each concerned IM);
- the IM allocates the path which is identified by a number called Train Number. This Train Number is attributed by the IM (or the IM responsible for allocating the Train

<sup>10</sup> E.g. UIC leaflet 407-1, PCS (Pathfinder), TIS (Europtirails).

<sup>11</sup> Some countries use alphanumeric system (e.g. GB).

<sup>12</sup> OPE TSI is the TSI for rail operations. See <http://eur-lex.europa.eu/LexUriServ/LexUriServ.do?uri=OJ:L:2011:144:FULL:EN:PDF>

---

Number for international train). It is unique on all the journey<sup>13</sup>, but some exceptions exist where the IMs attribute different Train Numbers on their sections according to local needs<sup>14</sup>;

- the path request and the answer can be gathered in a dossier. A dossier can also gather several paths requests (e.g. periodic timetable);
- the train running on the path is identified by the same Train Number.<sup>15</sup>

It happens quite often that the Train Number is attributed by the RU in the path request (and confirmed by the IM), e.g. when:

- a train is extended from one yearly timetable to the next;
- a range of numbers is granted by the IM to the RU;
- the path request follows a study phase where a Train Number was initially created for the study.

So, the path (object “belonging” to IM) and train (object “belonging” to RU) are identified by the same number called Train Number, inherited by the train from the path on which the train is planned to run.

A path/train is planned for a defined period<sup>16</sup>, it is therefore necessary to indicate the running dates of the path/train, as defined within its calendar (set of dates when a train runs within the same timetable).

In planning phase, if a path/train has slight deviations on certain days to its normal running, it is usual that the Train Number remains the same (and a variant is added to the Train Number to identify the different sets of days<sup>17</sup>). One way for doing so is linking the train number to different calendars. It can also happen that, instead of adding a variant, the Train Number changes (according to national rules)

In daily operation, the variant is no longer needed to identify the daily train as the running date is linked to the Train Number.

## 9.2 Train and Path Identification in Planning IT systems

### 9.2.1 Numbers

Identification rules during planning phase depend on the national regulation, organisation and planning system. Nevertheless, some principles are universally applied in all planning system:

- a path request is sent from the RU planning system to the IM planning system. It receives a Path Request Number used to retrieve the answer or to modify the request. The RU can indicate in the path request a preferred Train Number;
- the answer (path details) from IM to RU receives an Answer Number linked to the Path Request Number and contains planned timetable and running days (calendar). The answer indicates the Train Number attributed to the path by the IM (or the IM responsible for allocating the Train Number);
- a dossier can be created to gather path request(s) and answer(s). It receives a Dossier Number.

---

<sup>13</sup> Some countries use consecutive even and odd train numbers. It is considered as a unique Train Number

<sup>14</sup> For example when national Train Number rules impose specific ranges of number, e.g. for agency trains.

<sup>15</sup> If different trains use the same path on different days (e.g. RU A on Monday, RU B on Wednesday), different Train Numbers might be used for the different days.

<sup>16</sup> This can cover the yearly timetable or a period within the timetable.

<sup>17</sup> Variant (set of days when a train is running) is different of **version** (indicating that an update is done). The different variants describe different sets of days and have no hierarchy. Concerning versions, only the latest is valid, the others can be deleted (or kept for historical records). So, a variant can have different versions.

### 9.2.2 Commonly Used Systems

Some IMs and RUs use a common tool for the coordination of path requests<sup>18</sup> to follow path requests and answers across different networks. For international path requests, these are currently used by many RUs/IMs across Europe for handling such type of requests. In this tool:

- the dossier, created by the Lead RU, receives an integer (long) Dossier-ID allocated by the system and contains the path request (requested RU-timetable and the reference calendar). The Dossier-ID number can be seen / can be used also as the Path Request Number. The Dossier in this tool is capable of handling different variants of the requested timetable – such variants are stored as separated requested RU-timetables with their own corresponding reference calendars. Actually, every requested RU-timetable has its own unique identifier number generated by the system. The Dossier also contains placeholders for each RU to store their own specific request number (if, for example, generated by their national RU-IM ordering system).
- the Train Number is usually agreed in advance with the one of the IMs responsible for the management of the train number and filled in the tool by the Lead RU;
- network sections of the path request are distributed by the tool to the IMs involved in the whole journey;
- the answer by each IM is added to the dossier with the relevant calendar (depending on RUs requests and IMs answers). The network sections of involved IMs are compiled into IM-timetable, which is used as the path offer within the dossier. If there were several variants of the requested RU-timetable, the IMs can produce the corresponding IM-timetables for the offer. Note that each IM-timetable has unique ID (long integer number) generated by the system. Moreover, each path section has its own unique ID (long integer number) generated by the system.
- if, in some cases, an IM attributes another Train Number on its network, the path remains designated in the tool by the Train Number allocated by the one of the IMs responsible for allocating the Train Number and filled by the Lead RU. In the IM timetable, the IMs can indicate their specific Train Numbers for each path section.

During planning phase with the tool, the Dossier Number is used by IMs and RUs to link path request(s) and answer(s). Train Number (allocated by one of the IMs responsible for allocating the Train Number) can also be used.

### 9.2.3 Without the Commonly Used System

If the tool for coordinating path requests is not used for international/interoperable trains, different path requests (with different Path Request Numbers) are sent to each concerned IM. If each involved RU sends the path request message (with different path request numbers) to the concerned IM for the relevant path section(s), all RUs have to ensure that they do not only give information regarding the appropriate path section(s) but also indicate origin and destination of the train run, if more than one network is involved. If the Train Number is already known (e.g. because it was agreed by meetings between RUs and IMs), RUs can indicate the common Train Number in each path request. Based on these options, the IMs will be able to coordinate the path details at the handover points.

<sup>18</sup> One widely used tool is PCS (Planning Coordinating System), managed by RNE (Rail Net Europe)

The answer of each IM has usually its own Answer Number linked to Path Request Number. Answer Number depends on national rules and planning systems. A dossier can be created to gather path request(s) and answer(s).

The harmonisation phase without a common tool shall ensure the continuity between IMs networks of the paths allocated by each IM, all these paths having the same number ("Train Number") given by the one of the IMs responsible for allocating the Train Number (for freight trains) or by agreement (especially for passenger trains, e.g. during FTE). It could nevertheless happen that according to its network rules an IM allocates a number different of the common one.

Each path recorded by the IM in its planning system has a first point (origin of the train or the entry point of the train in its network) and a last point (destination of the train or exit point of the train from the network). Last point of the sending IM and first point of the receiving IM (handover point) are usually the same but can be different (in this case, they are geographically close).

During harmonisation phase, IMs ensure that:

- the Train Number is the same at the last point of the sending IM and at the first point of the receiving IM;
- last point and first point have a planned date/time.
- Alternatively, the number of the sending IM and the number of the receiving IM are known by both.

The Train Number is very often the same for the whole path. Nevertheless, in some cases, another Train Number (than granted by one of the IMs responsible for allocating the Train Number) is allocated by an IM. That is not a problem:

- for IMs, important is that the Train Number at the last point of one IM and the first point of the next IM is the same. This common Train Number is used to designate the path between both IMs;
- a RU receives the timetable with the relevant Train Number for each section. To designate the path, the Train Number at first section is usually used for communication between the IM and the RU.

During planning phase with national systems, the existing Path Request Number (or the existing Dossier Number) is used by IMs and RUs to link path request(s) and answer(s). Agreed Train Number can also be used.

### **9.3 Train and Path Identification in Operations systems**

In operations, the train inherits for the whole journey the same Train Number than the Path Number. In the case where a path receives during planning phase different Train Numbers<sup>19</sup>, the train inherits these Train Numbers for the changed sections.

For operation messages between two IMs (from the train sending IM to the train receiving IM), the receiving IM compares the information sent by previous IM (Train Number at last

<sup>19</sup> Remember that the use of fair and odd Train Number is not considered as a train number change when specified in national rules.

point and planned date/time) with the information stored in its operations system (planned Train Number at first point [must be the same] and planned date/time [must be the same or close<sup>20</sup> ,]).

For operation messages from IM to RU running on its network, the RU compares the information sent by IM (Train Number at the relevant point of the message<sup>21</sup> and planned date/time) with the information stored in its operation IT system (planned Train Number at relevant point [must be the same] and planned date/time [must be the same]). Same principles apply for message from RU to IM.

If due to incident the Planned Train Number must be changed in operation<sup>22</sup>, the new Train Number is used in the messages and a Reference Train Number is also sent (as described in UIC leaflet 407-1 and e.g. implemented in TIS). The Reference Train Number is the planned Train Number (before Train Number changes) and can be optionally completed by:

- the Reference Train Number Location (same principles with the relevant first point or last point);
- the Reference Date/Time at Reference Train Number Location;
- the Referee IM (receiving IM in case of IM to IM messages).

Experience shows that the planned Train Number in operation for passenger trains changes very occasionally, even in case of rerouting or delay of several hours. So, for the transitional period before the WG10 TR-ID is implemented as mandatory, Reference Train Number does not need to be implemented if it does not already exist in the IT systems. The rare cases of number change in operation will be treated “manually” between the concerned actors, and the relevant IT systems will be updated manually.

In freight business, rerouting of trains and trains with a huge delay cause a new operational train number. IMs that are using already a Reference Train Number will be able to manage the change of train numbers. If this is not the case, a manual action is needed in order to secure the information between IMs and IMs as well as IMs and RUs.

During operation, the Train Number at relevant point (first point, last point, current point depending on message) and planned date/time at this point are used by IMs and RUs to designate a train. If necessary, Reference Train Number (Planned Train Number) is also used (recommended only if it is already implemented).

<sup>20</sup> The time-frame has to be implemented in each company operations system, e.g. a two hours time-frame is applied in some company applications and in TIS (Train Information System, that is a common platform managed by RNE to monitor international trains).

<sup>21</sup> Origin or first point to designate the whole path, current point for Train Running Information or Delay Cause, concerned point for Forecast.

<sup>22</sup> Message 2008 of UIC leaflet 407-1 describes the Train Number change message.



9.4 Summary

Summary of current identifications used in planning and operation

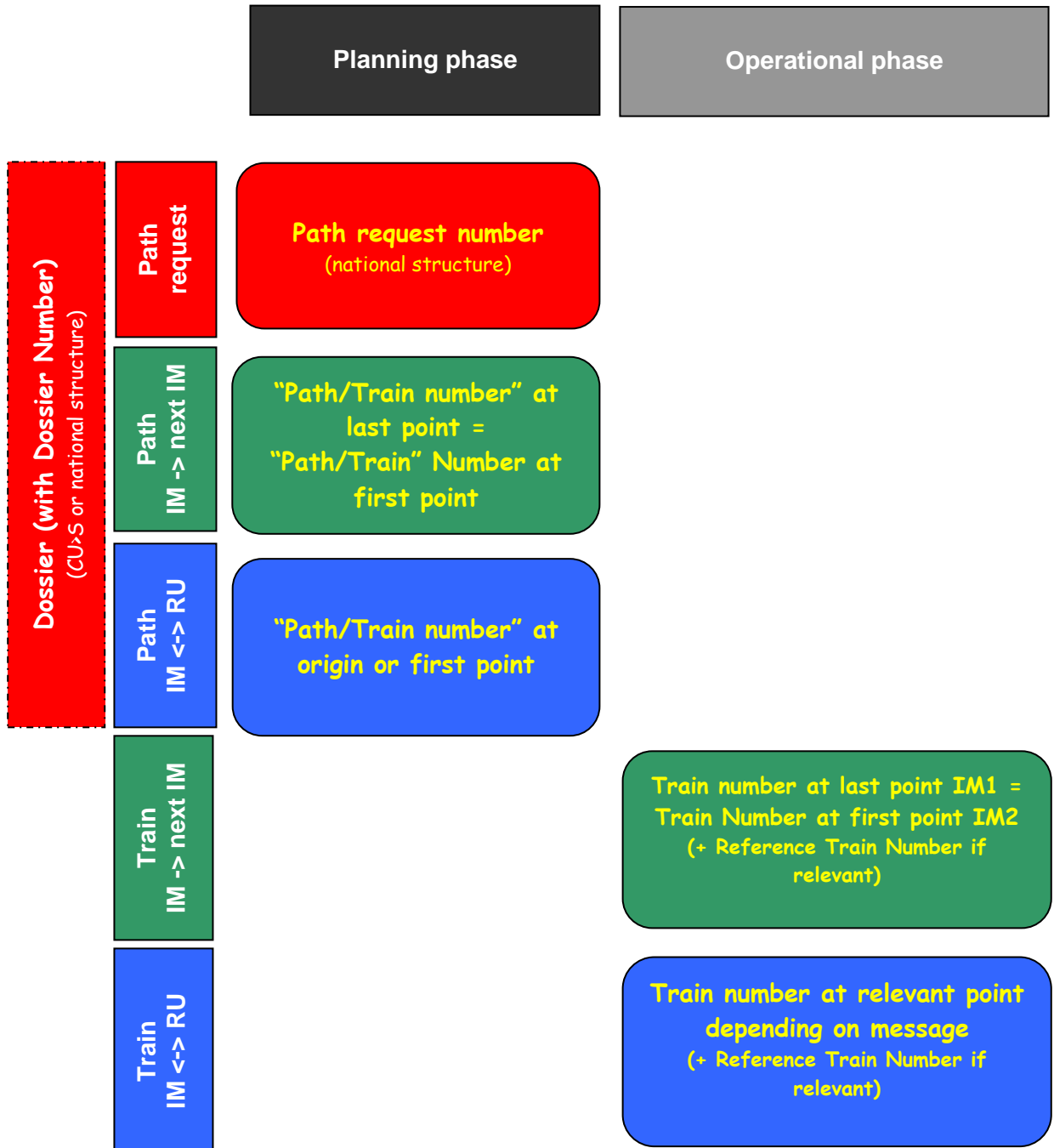

## 10 Reference Data

### 10.1 Reference File Implementation Guidelines

This chapter describes the Implementation Guidelines for TAF and TAP TSI Reference Files for Countries, Companies and Locations and Subsidiary Locations

The Reference files comprise:

- Countries
- Companies
- Locations
  - Primary
  - Subsidiary

The legal requirements for the reference files are derived from TAF 4.2.1.2 and TAP 4.2.19.1.

TAP TSI only The section hereunder is relevant for TAP TSI only and has no impact on TAF.	TAF TSI only This section hereunder is relevant for TAF TSI only and has no impact on TAP.
For the operation of passenger trains on the European network, the following reference files must be available and accessible to all service providers (infrastructure managers, railway undertakings, authorised third parties and station managers). The data must represent the actual status at all times.	For the operation of freight trains on the European network the following reference files must be available and accessible to all service providers (IMs, RUs, logistic providers and fleet managers). The data must represent the actual status at all times.

- reference file of the coding for all infrastructure managers, railway undertakings, station managers, service provider companies,
- reference file of the coding of locations,
- [...]

Other reference files, e.g. for Retail, and the use of location reference data for TAP Retail are not in scope of this documents.

### 10.2 Document Objectives

This Implementation Guideline describes how to deal with various reference files that are shared between TAP and TAF TSI and could be used for legacy systems and additional purposes (e.g. RINF...)

- Definition of the reference files and content
- Initial load of the reference file data base (National location allocation entity)
- The options for processes to maintain the reference files
- Regular maintenance of the reference files (responsible entities, companies)

- Update local copy of the Reference files on the local Common Interface

In particular, the Implementation Guidelines for TAF and TAP TSI Reference Files is an essential document to ensure that usage of Location descriptions within the TAF and TAP TSI framework is well defined and processes for regular operation are available to populate and maintain the data. Governance arrangements for the regular operation are proposed.

This document describes the Implementation Guidelines and the governance arrangements for the development and implementation. Finally, the document includes some technical appendices which describe the data being held.

The Implementation Guidelines contain all the necessary content to meet these objectives.

It is in the scope of the document to describe:

- the content of the Reference files,
- Possible actors
- possible Maintenance scenarios of Reference files
- the access policy for use of the Reference files within the TAF and TAP framework

It is out of scope of the document to describe:

- a detailed time table for Implementation
- national processes
- company Hardware- or Software solutions

Normalised codes are needed to support data exchange as defined in the Technical Specification for Interoperability (TSI) relating to the subsystem Telematic Applications for Freight of the Trans-European Conventional Rail System and Telematic Applications for Passenger referred to in Council Directive 2008/57/EC. To ensure data quality, the TSI for Telematic Applications for Freight and for Passenger (TAF and TAP) defines the need for centrally stored and administered reference files to be a repository for these codes. These codes and reference files ensure consistency of data interpretation across various application systems.

### **10.3 Location reference file**

The figure below shows the process to maintain Location reference files (process is identical for primary and subsidiary codes, but actors and actors rights can differ)

# European Railway Agency

ERA/TD/2012-11/INT Annex B.56 of TAP TSI

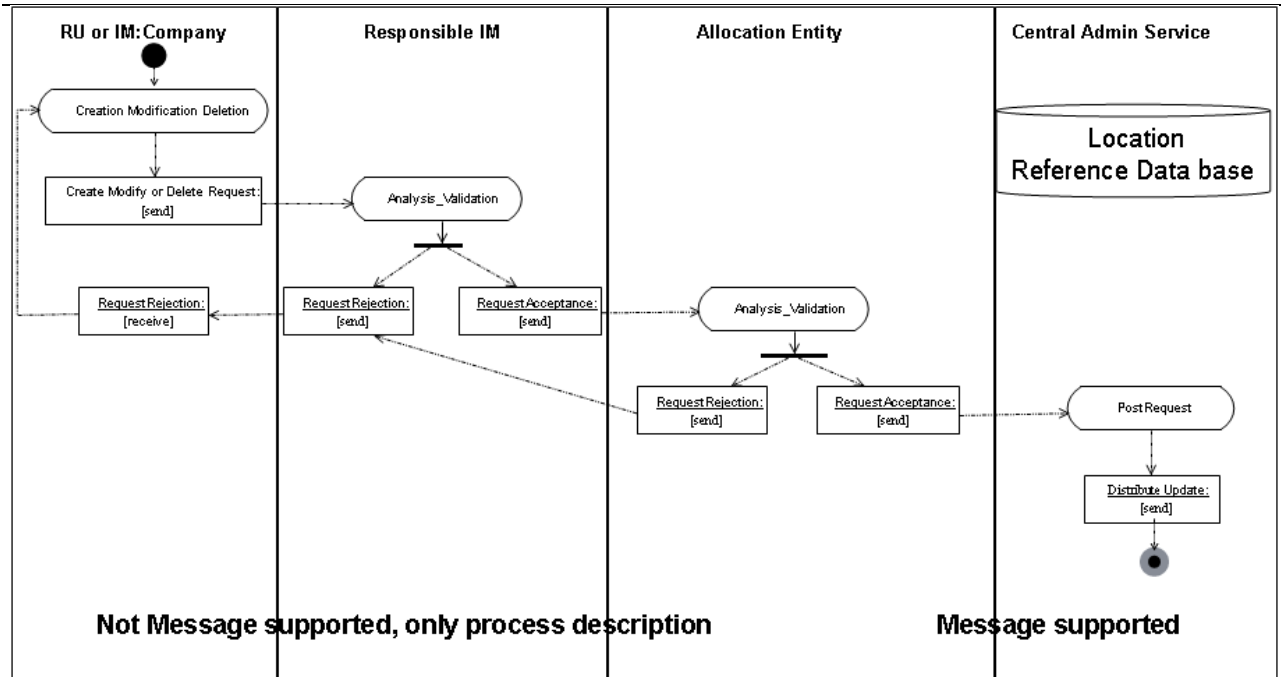

The TAF and TAP TSI Location Reference Data base is also known as the Central Repository Domain (CRD).

The figure below show the different possibilities to maintain the location reference files.

Maintenance of Reference files by National Location Entities (or registered companies for defined subsidiary type codes)

via

- Application (WEB GUI) central site
- Messaging (through common Interface)
- Bulk import by central administrator

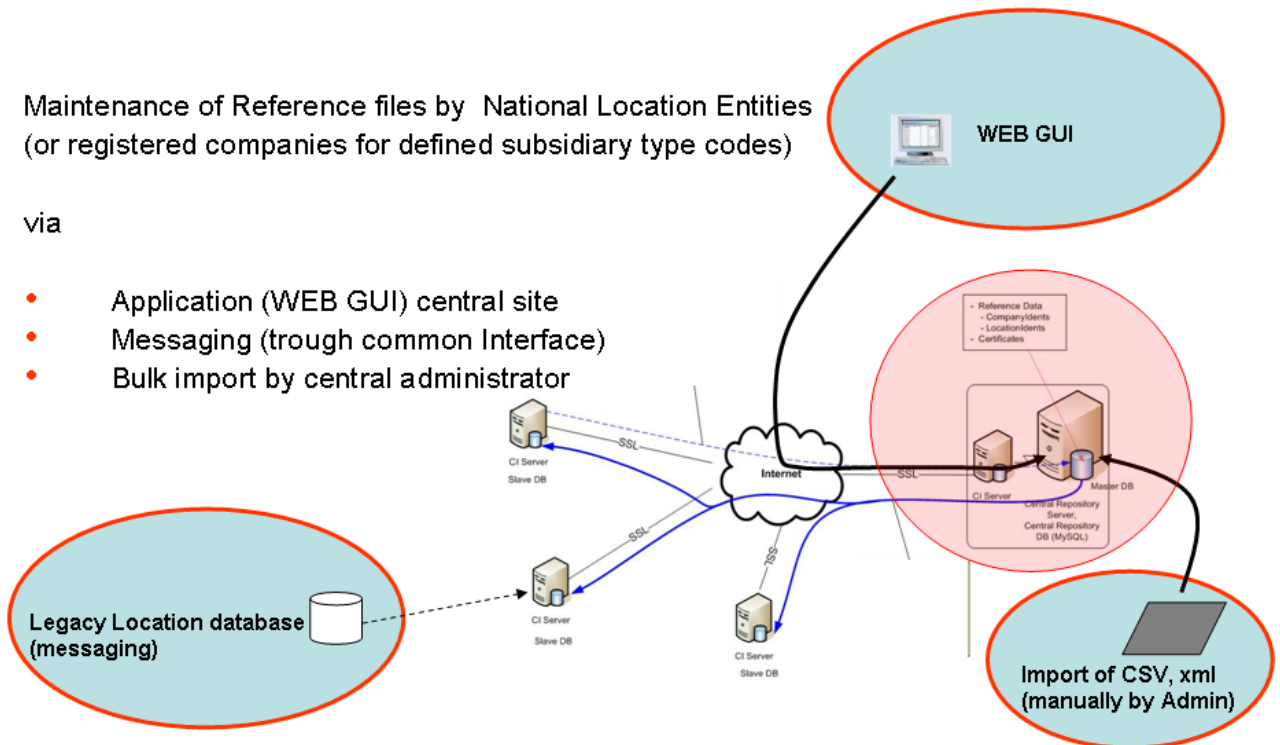

To get access to the reference files there will be different possibilities:

- For people, the reference files will be accessible via a web browser to view them, edit and upload them, if necessary rights defined for the user.
- For applications, there will be a web service provided by the Central Repository Domain (CRD)
- For use within an IM or RU with local Common Interface, there will be a scheduled replication service from the CRD to a local Common Interface. The scheduler could be configured on the local Common Interface
- Use of a web service provided by a local Common Interface accessible for a company application

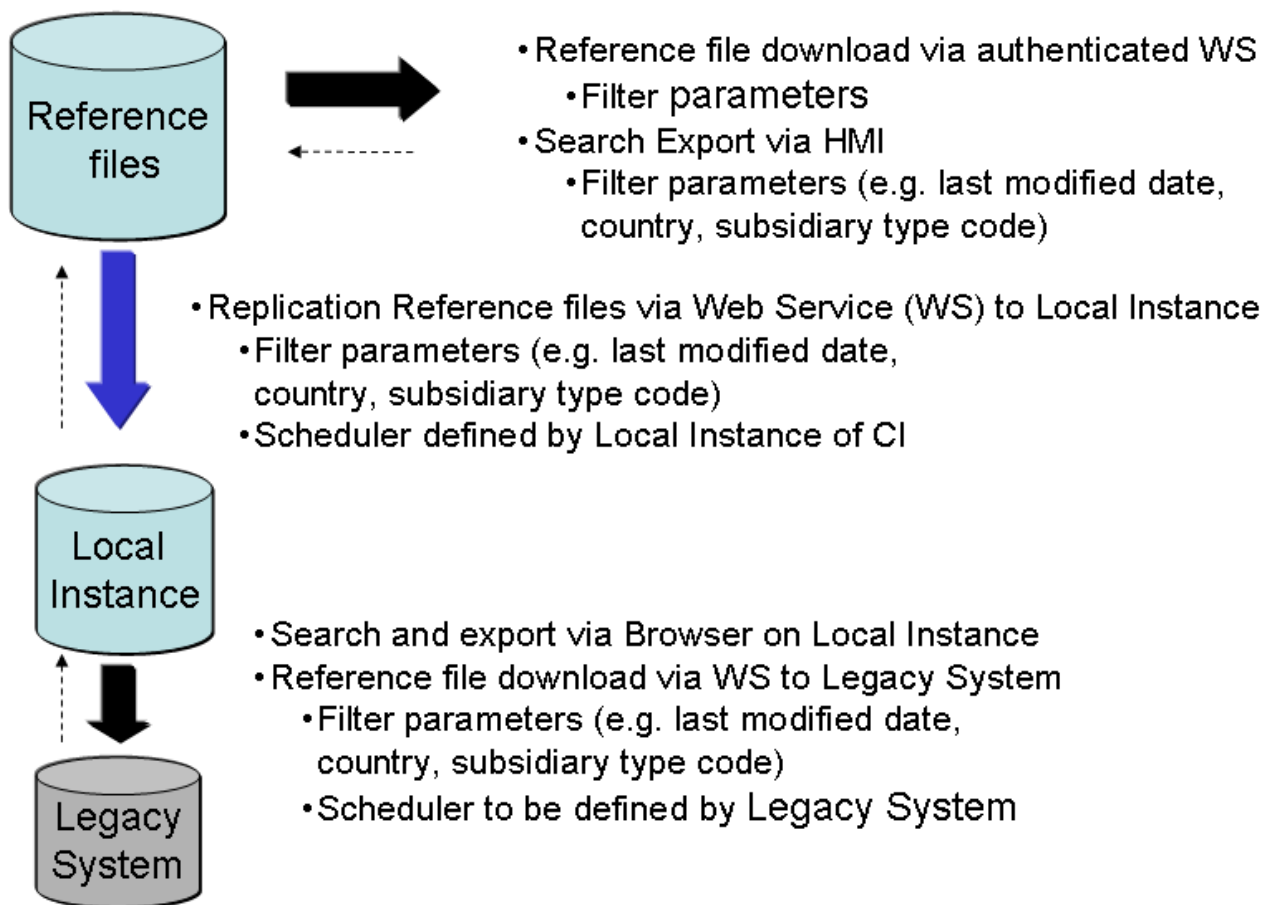

## 10.4 Regular Maintenance

Within each EU country a " National Location File Entity" will be responsible for ensuring that the TSI Location Reference files are maintained.

The Process to update the location reference files is provided as figure in Chapter 10.3.

## European Railway Agency

ERA/TD/2012-11/INT Annex B.56 of TAP TSI

Company Codes will be allocated and administered by a central administration service (CAS) in cooperation with OSJD. Currently the registratoin Entity is UIC (RICS) which is already maintaining the 4 digit RICS code. The RICS code will be transferred to the TAP and TAF TSI reference files for Companies. Each participant of TAP and TAF TSI message communication and Locations files maintenance needs to have a company code. Company Codes can be requested on UIC WEB Page: <http://www.uic.org/spip.php?article311>.

Country codes are maintained by the International Organization for Standardisation (ISO). Should a new country code be required or amended the requester should follow the process as laid out by ISO and documented on their website. [www.iso.org/iso/country\\_codes.htm](http://www.iso.org/iso/country_codes.htm)

### 10.4.1 Roles in Regular Operation

TAF and TAP TSI has defined an agreed set of actors. This section lists which actor type is particularly responsible for which type of activities:

Actor Type	Responsibility of activities
Administrator of the CRD	Maintains the centralized Reference file system Establishes and maintains new users and the technical interface for the maintenance of reference files based on the agreed governance
International Reference File Entity	Maintains common European location definitions (e.g. types of subsidiary locations, Border – Definitions) independent of a country or company. Defines, which Subsidiary Location Type can be attributed (maintained) directly by actors if National Location File Entity allows this for its country.
National Location File Entity	Is responsible for maintaining the uniqueness of locations codings within a country. The National Location File Entity has to be agreed at a national level. It is specified in the Company Code List, who is the National Location File Entity. (In many countries the largest IM has taken on this role.) The National Location File entity decides if Subsidiary Location Types can be maintained directly (CRUD) by Allocation Companies (RUs, SMs).
Infrastructure Managers	Are accountable for ensuring that their locations are correctly coded in the CRD. (This may mean that an IM takes direct responsibility for the maintenance of locations within their network if a National Location File Entity is not defined or if a country has one IM only.)
Railway Undertakings	Are accountable for ensuring that their subsidiary locations are correctly coded in the CRD.

## European Railway Agency

ERA/TD/2012-11/INT Annex B.56 of TAP TSI

	They may, if allowed by national governance, take direct responsibility for the maintenance of subsidiary locations for defined subsidiary type codes.
Station Managers	Are accountable for ensuring that their subsidiary locations are correctly coded in the CRD. They may, if allowed by national governance, take direct responsibility for the maintenance of subsidiary locations for defined subsidiary type codes.
Allocation Company	A stakeholder defined on national level authorized to attribute Subsidiary Location Codes for specified subsidiary type codes. The National Location File Entity will define the rights of an Allocation Company
Others (i.e. other stakeholders under the TAF or TAP TSI definition)	May request the creation of primary locations by National Entity or responsible IM
Guests (i.e. not TAF or TAP TSI stakeholders)	May be permitted read-only access to reference files. This category of actor includes all service providers IMs, RUs, SMs, logistic providers and fleet managers

### 10.5 Project Actors for Reference Data

The actors will be classified as one of:

- Administrators
- International Reference File Entity
- National Reference File Entity
- Infrastructure Managers
- Railway Undertakings
- Station Managers
- Others
- Guests

Following the governance individual named actors could be assigned for special tasks and executive power to take decisions, e.g. EU Commission, ERA, TAF and TAP Steering Boards, Provider of common elements [is procured by the Governance Entity].

## **10.6 Quality Criteria indicators**

This section explains the Quality criteria for the Reference Files, in particular

- the delivery of Reference Files by responsible actors according to deadlines and
- their successful validation.

The completeness and uniqueness of primary locations are validated by IM in consideration of all locations which could be used in Messages between IM and RU. Missing locations will be added by the responsible National Location File Entity.

A company using a primary code in messages has to make sure that this code is available in the Reference File or that the partner receiving the code has knowledge about its meaning.

The National Location File Entity is responsible to ensure that a location is unambiguously coded (avoid doubling/ different primary codes for the same physical location).

The completeness of Subsidiary Location is to be secured by the IM responsible for mandatory Subsidiary Location types (as defined commonly).

Additional Subsidiary Location will be regulated by the railway sector based on the business needs. Therefore the completeness will be secured by the railway sector itself. An actor using a subsidiary location code has to make sure that this subsidiary location code is available in the reference file or that the partner receiving the code has knowledge about its meaning.

Uniqueness of Subsidiary Location coding code will be secured by the respective National Location File Entities or the Allocation Company if available.

In case an Allocation Company ceases to exist, rules have to be in place for how long the Subsidiary Code remains in the Reference Files or is handed over to a following company [manual process]. A company code cannot be deleted until all Subsidiary Codes using this code are deleted or handed over.

## **10.7 Data to be held**

### **10.7.1 Company Description**

The present document describes a coding structure to identify unambiguously and uniquely:

- Railway companies as defined in the Technical Specification for Interoperability - Telematics Applications Freight Services (TAF-TSI) and TAP derived from the Directives 2001/14/EC and 2008/57/EC;



- Other transport bodies;
- Any other company involved in the rail transport chain.

The defined coding structure of CompanyIdent meets the requirements and vision of the TAF and TAP-TSI<sup>23</sup>. It can be used in various applications and for different purposes (documents, messages, marking, etc.).

The coding structure has sufficient flexibility to satisfy the expected demand for codes requested in the forthcoming decades in the current EU single market, its possible expansion and operation with non-EU member States.

The definition of Company comprehends the following as defined in the TAF and TAP-TSI.

- IMPartner;
- NextResponsibleIM;
- NextResponsibleRU;
- Recipient;
- ResponsibleIM;
- ResponsibleRU;
- PreviousResponsibleRU;
- RUPartner;
- StationManager
- Sender.
- Receiver

Further on only CompanyIdent is used<sup>24</sup>.

Company Code	N1	N2	N3	N4
0001 - 9999	x	x	x	x
Code Example	3	3	4	5

More details are to be found in Annex 9.1 of this Implementation Guide.

The code is unique within Europe

Currently the code uses numerics only, but for future use the code should be implemented in company applications as alpha-numeric to be flexible enough if more than 9999 is needed.

### 10.7.2 Country description

This element indicates the type of a field containing the coded identification for a State/Country as defined by ISO 3166 – 2 position alpha code (2A).

<sup>23</sup> ERA Technical Documents for TAF TSI - ANNEX D.2 : APPENDIX C - REFERENCE FILES and TAP-TSI B.8

<sup>24</sup> TAF described a PartnerIdent which is similar to CompanyIdent and consequently is no longer used independent.

## European Railway Agency

ERA/TD/2012-11/INT Annex B.56 of TAP TSI

Country Code	A1	A2
	x	x
Code Example	D	E

More details is to be found in Annex 9.1 of this Implementation Guide.

### 10.7.3 Location Description

Location is a place, a geographic point, inside or outside the rail network, which is needed to be identified for operational, technical, administrative or statistical purposes. This can be either a Railway or a Customer location.

Locations can be Stations, Yards, Halts, Terminal or Transhipment Points, Loading Points, Marker Points, Warehouses, Maintenance Workshops, Traction Departments, Town Offices, Railway frontier-points, transit-points, hand-over points and interchange points, Customer Sidings, Travel Agencies, Sales Points, Tracks and so on. It can also represent a part or section of them.

#### Coding of a Primary Location

This element identifies a location by its code. A location denotes a place used for technical, commercial, operating or administrative purposes and which belongs to or is connected with a transport enterprise. This location must be a network rail point managed by an Infrastructure Manager (IM).

	A1	A2	N3	N4	N5	N6	N7
Code Example	D	E	9	0	3	0	0
Data Description	Country Code		LocationPrimaryCode				

More details is to be found in Annex 9.1

- The first two characters (2Alpha) contain the ISO 3166 Country Code defining the country where the location is (e.g. DE = Germany);
- The next five characters (5N) contain a non-significant LocationPrimaryCode to identify the location;
- The LocationPrimaryCode has to be unique per country and each physical location shall have only one LocationPrimaryCode
- Stations and part of stations will be having their own primary location code.

Country Code and LocationPrimaryCode are used in messages to identify a (primary) location. Within the Central Reference File, the key consists of the Validity Start Date as well.

#### Coding of a Subsidiary Location

## European Railway Agency

ERA/TD/2012-11/INT Annex B.56 of TAP TSI

This element identifies a subsidiary location as a part of a primary location e.g. a junction, a signal, a marker point, track, border point, sales office etc. This may be a non-rail point or a rail point that is not managed by an Infrastructure Manager (IM).

	A1	A2	N3	N4	N5	N6	N7	ID1	ID2	AN10	AN11	AN12	AN13	AN14	AN15	AN16	AN17	AN18	AN19	N1	N2	N3	N4
Code Example	D	E	9	0	3	0	0	0	2	1	2	3	4	5	6	7	8	9	0	3	3	4	5
Data Description	Country Code	LocationPrimaryCode						Location Subsidiary Type Code	LocationSubsidiaryCode											Allocation Company			

More details is to be found in Annex 9.1

The Subsidiary Location is optional and dependant upon business needs.

It is always associated with a Primary Location and is always comprised of a LocationSubsidiaryTypeCode, LocationSubsidiaryCode and AllocationCompany.

All these elements make the Subsidiary Code unique.

Country Code, LocationPrimaryCode, SubsidiaryTypeCode, LocationSubsidiaryCode and AllocationCompany are used in messages to identify a subsidiary location. Within the Central Reference File, the key consists of the Validity Start Date as well.

- The two characters (2AN) comprise a pre-defined code, LocationSubsidiaryType Code. Code '00' is undefined.
- The predefined codes are maintained by an European Entity [which has to be defined]. More details can be found in Annex 9.4.
- The next one to ten characters (1AN - 10AN) comprise a non-significant LocationSubsidiaryCode to identify a "dependent" location defined together with the LocationPrimaryCode.
- The Allocation Company in the Subsidiary Location is a part of the primary key of the location subsidiary code.
- The validity of the Subsidiary Location is bound to the life span of the Primary Location. There can be no Subsidiary Location without a valid Primary Location.

### Subsidiary type codes

Locations are defined by a primary location code and optionally by an subsidiary location.

Primary locations are used for Stations and part of stations. Within the messages between IM and RU in most cases only primary codes are used. Primary locations are used always for the level of stations of part of Stations. They will be maintained usually by the Infrastructure Manager or a national location file entity.

Subsidiary locations are mainly used between the Railway Undertakings where detailed information within a primary location is needed.

For specific reasons as specified in certain messages for the communication between IM and RU the primary location needs to be further detailed, e.g. to indicate a specific track in the station. Therefore, subsidiary locations can also be used in messages between RU and IM.

---

A subsidiary location depends always on a primary location. Subsidiary locations are grouped by subsidiary types. The types are part of the key. Each Subsidiary location is allocated by an Allocation Company. Bases on national rules Freight and Passenger Companies are allowed or not to maintain subsidiary locations for certain subsidiary types directly in the central Reference file system.

An initial coding is based on the CEN workshop and TAF / TAP Expert-Groups to support the messages within the TAF and TAP TSI framework.

The code for Subsidiary locations for some Subsidiary type code should be maintained mandatory by Infrastructure Manager, e.g. Relations between Stations (99) or by UIC, e.g. Boarder Points (03).

The coding was established under the premise to support the coding of subsidiary Locations

- in TAF and TAP TSI messages
- in the related business (applications)
- other useful locations e.g. for network statement

The coding is available in a separate excel file.

After the initial proposal further or adapted Coding will be established by related Coding Group and may be maintained as separated code shemas.

### **Description of the whole location data set (xml)**

The data set is described in Annex 9.1 and the description of the update message in xml is described in the message data catalogue (Annex 1)

### **10.7.4 Initially population**

Use case

1. Initial loading of locations **Central CRD Admin**
  - a. select and import from European Railway Locations Database (ENEE)
  - b. by an delivered CSV (structure for CSV and XML to be proposed by contractor)Bulk upload is delivered to the National Location File Entity. The National Location File Entity hands the bulk file to the Central CRD Administrator.

### **10.7.5 Maintenance Use case**

1. (CRUD: Create, Read, Update, Delete)
2. Bulk import during operation by **Central CRD Admin**
3. CRUD by **Central Entity Companies and Countries** independent of CountryCodeISO and Company code)
  - a. Companies
  - b. Countries

## European Railway Agency

ERA/TD/2012-11/INT Annex B.56 of TAP TSI

---

4. CRUD by **Central Entity Locations** for all locations (independent of CountryCodeISO and Company code)
  - a. LocationPrimaryCode
  - b. LocationSubsidiaryCode
  - c. LocationSubsidiaryTypeCode
  
5. CRUD by **Central Entity LocationSubsidiaryCode for defined LocationSubsidiaryTypeCode**  
Constrain:  
Maintenance of LocationSubsidiaryCode for defined LocationSubsidiaryType Code (no restriction of Country, Company)
  
6. CRUD by **National Location File Entity (NE)** for all locations  
Constrain: Location ISO Code of LocationPrimaryCode has to be same as User (Company) of the NE [?]
  - a. LocationPrimaryCode
  - b. LocationSubsidiaryCode
  
7. CRUD by **IM** for all locations  
Constrain:  
Element "ResponsibleIM" (Company Code) in LocationFileDataset has to be same as User (company) of IM  
Element "AllocationCompany" in LocationSubsidiaryCode has to be same as User (company) of IM
  
8. CRUD by Registered **RU, SM** (User) for LocationSubsidiaryCode  
Constrains:  
only if allowed for this country (to be defined by configuration in country file);  
only for LocationSubsidiaryCode at which the subsidiary type code is flagged "maintenance allowed by RU"
  
9. CRUD by Registered **others** (User) for LocationSubsidiaryCode  
Constrains:  
only if allowed for this country (to be defined by configuration in country file);  
only for LocationSubsidiaryCode at which the subsidiary type code is flagged "maintenance allowed by others"
  
10. CRUD by Registered **Central Entity** "LocationSubsidiaryCode (User) for LocationSubsidiaryCode  
Constrains:  
only for LocationSubsidiaryCode at which the subsidiary type code is flagged

## 11 Code Lists

This chapter provides an overview of codes used in the RU/IM message exchange. The code lists can be found in Annex 10.

The annex also notes the category of codes (A, B, C) relevant for maintaining the codes. See chapter 24.1 for the maintenance of the different classes of codes.

### 11.1 codes

Specific values that are needed in some of the elements used in messages:

- PathDossierError<sup>25</sup>  
A list of errors of the elements of the Path Request Message, applicable for all elements, Passenger specific, Freight specific and Common elements

Note: In addition to the error codes for the main TAF/TAP elements in the messages, the code list can be extended to include error codes for custom elements (defined in National Specific Parameters) that will be used by RU/IMs within their specific network. These will have to be user definable codes created by the IM

- Tilting Function<sup>26</sup>  
A list of options available for a Passenger train with tilting capability
- Traction Mode  
A list of two digit codes identifying the type of traction unit and its position in the group of units, applicable for both Passenger and Freight traffic
- Train Activity Type  
A list of common activities that can take place at a location. This covers RU and IM activities that take place for Passenger and Freight traffic e.g. Change of Engine required by an RU, Operational Stop required by an IM
- Train CC System  
A list of train control systems that are available in Europe
- Train Radio System  
A list of train radio Systems used for voice and messaging communications
- Train Type  
A generic list of train types covering passenger, freight, engineering and any other trains
- Traffic Type

---

<sup>25</sup> Waiting approval by Change Control Management

<sup>26</sup> Waiting approval by Change Control Management

## European Railway Agency

### ERA/TD/2012-11/INT Annex B.56 of TAP TSI

---

A list of the types of traffic that can be operated by an RU for passenger services

- Type of RU Harmonisation / Type of IM Harmonisation  
A list of codes that define that status of harmonisation for RUs and IMs  
Note: Although the code values are the same, these have to be treated as separate Code Lists since the processes are considered separate
- Type of Request  
A list of the types of request that can be made by an RU
- Type of Information  
A list of the types of responses that can be given by RU or IM depending on the step in the process e.g. offer by an IM (Path Request process), activate path by an RU (Utilisation Notification process)
- Type of Location  
A list of the type of location that can be included in the Messages, both by an RU or IM e.g. Border Point, Origin
- Interruption Reason (Code list for Train Interruption) ; Delay Cause ; Delay Code  
A list of codes that denote the reason why a path is no longer available by an IM e.g. Flooding  
Note: This list is the same as the Code List given by the IM during an interruption of a train during its operation. It is therefore a code that is reused during the interruption caused in planning
- Train Location Status  
A list of status a train can have at a given station during operations, e.g. departure, passing through etc.

There are also a number of other reference codes that belong to other areas and functions across the wider rail process but are also linked directly to the planning process. These are predominantly commercial codes used in the retail sector but also in RU/IM communication

- Commercial Traffic Type<sup>27</sup>  
A list of Commercial Brand Name of the train service used by passenger RUs within Europe that are primarily used for retail purposes e.g. Eurostar. This is according to TAP Passenger Code List.
- Special service description code<sup>28</sup>  
A list of services on a train identified by a passenger RU that is primarily used for retail purposes e.g. Dinner service. This is according to TAP Passenger Code List.

---

<sup>27</sup> Waiting approval by Change Control Management

<sup>28</sup> Waiting approval by Change Control Management

## European Railway Agency

ERA/TD/2012-11/INT Annex B.56 of TAP TSI

- Facility type description code<sup>29</sup>  
A list of facilities on a train identified by a passenger RU that is primarily used for retail purposes e.g. Bicycle transport is available. This is according to TAP Passenger Code List.
  
- Characteristic description code<sup>30</sup>  
A list of characteristics on a train identified by a passenger RU that is primarily used for retail purposes e.g. First Class coaches. This is according to TAP Passenger Code List.

There are a also a number of other reference codes belong to other areas and functions across the wider rail process but are also used in planning

- Combined Traffic Load Profile<sup>31</sup>
- Exceptional Gauging Code
- Brake Type
- Route Class

### 11.2 Index of Code lists,

The following table gives an overview of the code lists with code category (according to chapter 24.1) and source. Details can be found in Annex 10.

For RU/IM Messages			
Element	Category	XSD Entity	Standard conform to
Brake Type	C		Rolling Stock Register / UIC 421
Characteristic description code	C		TAP Code List B.4.7037
Combined Traffic Load Profile	C		UIRR Leaflet
Commercial Traffic Type	C		TAP Code List B.4.7009
Company Id	C	Company Code	920-1 (RICS)
Coordinating IM	C	CompanyCode	920-1 (RICS)
Country Code ISO	C	CountryCodeISO	ISO 3166-2
<a href="#">Delay Reason</a>	<a href="#">C</a>	<a href="#">DelayReason</a>	<a href="#">EG2 / UIC 450-2</a>
Exceptional Gauging Code	C		UIC 404-2 ; 920-13; 505, 506

<sup>29</sup> Waiting approval by Change Control Management

<sup>30</sup> Waiting approval by Change Control Management

<sup>31</sup> Waiting approval by Change Control Management



## European Railway Agency

ERA/TD/2012-11/INT Annex B.56 of TAP TSI

Facility type description code	C		TAP Code List B.4 9039
IM Code	C	CompanyCode	920-1 (RICS)
Leading RU	C	CompanyCode	
Location Primary Code	C	LocationPrimaryCode	
Location Subsidiary Type Code	B	LocationSubsidiaryTypeCode	
Message Status	B		
Modification Status Indicator	A	ModificationStatusIndicator	
PathDossierError	B		
Responsible Applicant	C	CompanyCode	920-1 (RICS)
Responsible IM	C	CompanyCode	920-1 (RICS)
Responsible RU	C	CompanyCode	920-1 (RICS)
Route Class	C		CEN EN 15528
Special service description code	C		TAP Code List B.4 7161
Tilting Function	A		
Traction Mode	A		
Traffic Type	C		TAP Code List B.4 7009 - Service Modes
Train Activity Type	A	TrainActivityType	
Train CC System	A	TrainCCSyst	UIC 407-1
<a href="#">Train Journey Modification Indicator</a>	A	<a href="#">TrainJourneyModificationIndicator</a>	
<a href="#">Train Location Status</a>	C	<a href="#">TrainLocationStatus</a>	<a href="#">EG2 / UIC 407-1</a>
Train Radio System	A		
Train Type	A	TrainTypeCode	
Type of IM Harmonization	B		
Type of Information	B		
Type of Location	A		
Type of Request	B		
Type of RU Harmonization	B		

## 12 Message Header for RU/IM communication

This chapter describes the message header that is common to all TAF and TAP RU/IM Messages.

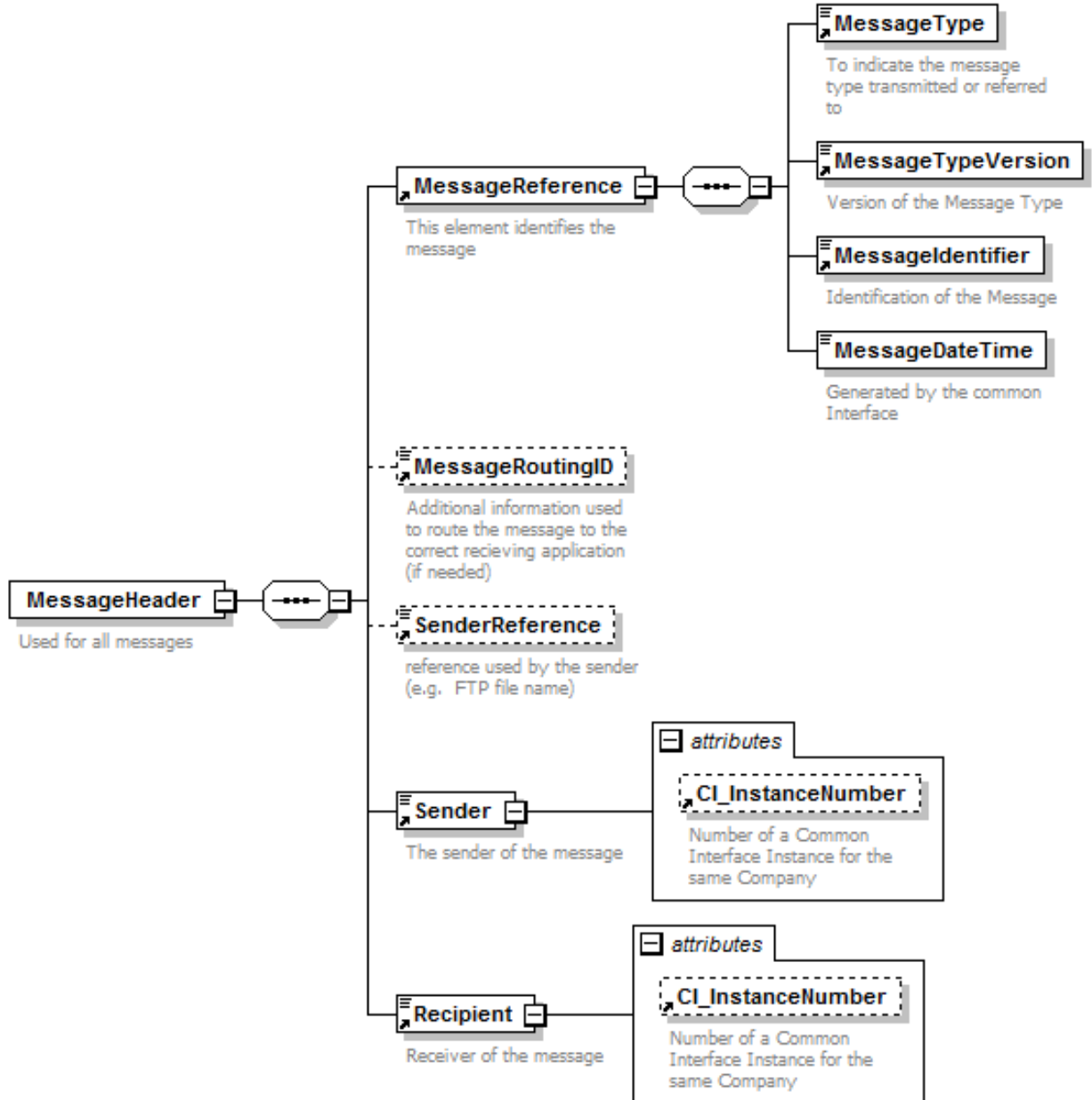

## 12.1 Explanation of Message Header Elements

The Sender, Recipient and Message type fields are used to route the message to the right recipient based on configuration on the sending CI.

This Header also MUST be used for shared metadata messages exchanged between two partners. (Shared Metadata describes messages which could be exchanged between two or more partners.) The format can be locally defined and shared between partners. This also allows using the Common Interface for enhanced xml-message exchange outside of the TAF and TAP defined metadata.

Element	Format	Description
Message Reference		
Message Type	4n	<p>The message type defines the functional message by a number. This is not yet codified and the identification of the messages is an outstanding task.</p> <p>As an example, value '2002' is a 407-1 2002 Running advice.</p>
Message Type Version	string ..25	<p>The message type version defines the version of the message. It will be the version of the schema. It is proposed to use for each Message a single schema.</p> <p>This will identify the version of the schema. For common metadata, this will be version of the metadata used, i.e. '5.1.8' for the current version the metadata.</p>
Message Identifier	String ..255	<p>The message Number is assigned by the CI to secure the transactions are uniquely identified between the CIs for reliable messaging. It has to be unique.</p> <p>The Message ID is a sting of 36 bytes. For technical point of view the MessageIdentifier is a universally unique identifier (UUID) created using java.util.UUID class. It is 128 bit value. We are using randomUUID() function of UUID class which generates UUID using a cryptographically strong pseudo random number generator.</p> <p>As string it is represented as a 36 bytes (128 = 16 bytes, each byte is represented by a two byte</p>

## European Railway Agency

ERA/TD/2012-11/INT Annex B.56 of TAP TSI

Element	Format	Description
		hex code. That makes it 32 bytes and there are 4 – separators)  If Company is using its own CI it has to produce the Message ID accordingly.
Message Datetime	datetime	The date and time will be given by the CI to report the last time when the message was send by the sender. It will contain the local time of the message sender.  (UTC instead of local time would have been possible. However, the convention is on local time with UTC offset)
Message Routing ID (optional)	2n	Normally the routing (configuration) on the Common Interface (CI) for incoming messages to the right legacy Application will be done based on the <b>message type</b> .  There could be a need to have an additional routing code to identify a particular application on the receiver's end. (i.e. routing to a combined transport or wagonload system.) In this case the <b>Routing ID</b> (defined by the receiver and agreed by the sender) allows definition and configuration on the receiving CI. Routing ID is mutually agreed by trading partners.
Sender Reference	string 25	This optional element allows the sending application to transfer a reference ID taken from the legacy message (e.g. ftp file number if unique) to the receiving CI and possibly to the receiving application (if supported). It could be used to link a legacy message with a TAP / TAF TSI Message over the translation Layer of the Common interface.
Sender	Company code string 4	The Sender defines the sender of a Message by its company ID. It will be configurable through message processing on the sending CI if not contained in the legacy message.
CI_InstanceNumber	2n (Attribute of Sender)	In case that a company has more than one CI (which is possible) the instance number is present as an attribute to identify the correct instance within a company. It will be configurable on the sending CI as a constant and should contain a default of "01"
Recipient	Company code string 4	The Recipient is the receiving Company defined by the Company ID. It could be defined by the sending application or done by the CI by

## European Railway Agency

ERA/TD/2012-11/INT Annex B.56 of TAP TSI

Element	Format	Description
		configuration. Origin information must come from the sending application (either contained within the message or by message processing configuration)
CI_InstanceNumber	2n (Attribute of Recipient)	<p>In case that a company has more than one CI (which is possible) the Instance number is present as an attribute to identify the correct instance within a company. It will be configurable on the sending CI as a constant and should contain a default of "01"</p> <p>For example, it would allow routing of operational messages to instance No 1 of Company A and timetable messages to instance No 2 of Company A.</p>

Sender Recipient and Message type are used to route the message to the right recipient based on configuration on the sending CI.

### 12.2 Example XML message after processing by the Common Interface

```
<MessageHeader>
  <MessageReference>
    <MessageType>2002</MessageType>
    <MessageTypeVersion>5.1.8</MessageTypeVersion>
    <MessageIdentifier>1c05811f-0dfc-4554-b9e2-1d053353b2bd</MessageIdentifier>
    <MessageDateTime>2011-10-04T19:34:39.062</MessageDateTime>
  </MessageReference>
  <SenderReference>2102.txt</SenderReference>
  <Sender CI_InstanceNumber="01">0080</Sender>
  <Recipient CI_InstanceNumber="01">0016</Recipient>
</MessageHeader>
```

### 12.3 Further explanation on Message Identifiers

The message ID is created by the CI immediately as the messages arrives on the CI not knowing any message structure at this time. This is necessary to log the legacy message at earliest stage. At CI it is used in all logs and also included in the messages in the Header element.

Even if it is provided from Legacy system it will be replaced from CI within the messages processing, even if there is no translation.

Example of logging of message ID:

```
INFO OutBoundMessageProcessingConnectorTextLogger - TS=2011-11-13 20:25:35,997
CET|MID=7142ac39-91a7-4b6d-93f6-0ecb542413c5|STS=RCVD|CT=IP
Socket|CI=0080_0083_out_2002_IPS|ENC=UTF-
8|SIZE=205|RM=2002018003000421732011114035048008022596NOBS Obersinn
20111113202334-004905008020178MKI Kiefersfelden
00810000000421732011114035048|
```

## 12.4 Payload of the Messages

The following chapters 13 to 19 and 21 will describe the detailed message payloads for

- Short Term Path Request
- Operation of Trains
- Train Preparation
- Train Running Information and Forecast
- Service Disruption/Train Running Interrupted
- Change of Track/Platform
- Train Journey Modified
- Delay Cause
- Train Location.

## Part B - Planning of Trains

### 13 Short Term Path Request

#### 13.1 Introduction

This complete chapter aims to provide the necessary planning specific information that is required for the implementation of the messages by the various stakeholders impacted as a result of complying with the TAF/TAP regulations. Other information that is related to planning, e.g. Train Identification, Architecture, can be found in dedicated chapters of this overall guideline document.

##### 13.1.1 Long-Term Planning linked with Short-Term Planning

The TAF and TAP TSIs were initially focussed on just the planning process for short term planning. As happens across virtually all networks in Europe annual train services have short term amendments made to them e.g. cancellation of the service for the day, change of route for a week. It therefore makes sense to use the same standards for annual planning and short term planning.

In addition to the diversity of processes there is also a fundamental need to identify a train service during the different phases of planning and into operation. A European Train Identifier whose main benefit is to have the same number across the various stages – that includes moving from long term planning into short term planning is used in the messages. Extending the TAF/TAP processes to include long term activities as well as short term the problem of train identification for planning can be overcome.

The use of the TAF/TAP processes for Long-Term Planning is a recommendation outside/in addition to both TSIs. It is therefore up to the involved parties to agree on using it.

##### 13.1.2 The need for Harmonisation

At present, there is no mandate as such for the regulations to include harmonisation<sup>32</sup> activities between:

- RUs when setting up a path request
- IMs when planning the path details

However, the handover point from one IM to the next IM, where the legal responsibility is changing, is rarely at a journey location. Often, it is on a line section (e.g. bridge, forest, meadow) and the trains do not stop there. This means, the RU interchange point is either in one of the journey locations before or after the handover point. In this case, RUs could have the need to collaborate for this section (e.g. who is requesting till where, which rolling stock is used). On the IM side, the times at the handover point are often just run through times. In any case, the times at handover provided by both of the IMs shall need to be the same. Therefore, some collaboration between the two involved IMs is required. In order to have a fully joined up 'Short-Term Path Request' process it could be considered that the harmonisation phases between the respective parties (RU to RU, IM

---

<sup>32</sup> However, Directive 2001/14 Article 15 requires IMs to cooperate with each other for the allocation of infrastructure capacity which refers to a harmonization process

---

to IM) are included as relevant activities. These activities take place currently in planning and they are incorporated into the overall process. However harmonisation is not included in the regulations therefore it has been made optional with a strong recommendation that RUs/IMs adopt them within their working practices.

### **13.1.3 Support Mechanism for Harmonization**

A support mechanism that has the capability to support and maintain the Short Term Path Request process as well as the information (messages) that the process produces helps in tracking and coordinating the different steps of a path request. Having such support not only helps to provide evidence of the message transactions that take place between the stakeholders but also to provide benefits such as auditability, traceability and data recovery (in the case where information can be lost by sending/receiving systems). Having the planning information stored commonly will also help with management reporting and the ability to measure how the process is being utilised by the different parties.

This common support mechanism is likely to be in the form an IT system or tool, that is common to the usage of TAF/TAP and that will work in conjunction with the Stakeholder systems. The tool will have to be fully compliant and could be adopted especially for the traffic involving more than one network or being interoperable in any other kind. Interactions to this tool within the specific processes that make up Short Term Path Request process (e.g. Path Request, Path Alteration) is represented by the swimlanes “coordination” and “order tracking” within the process diagrams themselves, see Annex 12.1.

The technical analysis of such a tool has to be carried out by interested parties. This will involve working with different stakeholders (RUs, IMs) in order to define the best way to interact.

The harmonization process also works when using a bi-lateral data exchange between two communicating parties<sup>33</sup> without a need of adopting the common support mechanism. The communication will use the same TAP and TAF standards.

## **13.2 Assumptions**

- The term “Short Term Path Request” process denotes a number of different processes that range from Path Request, Path Cancellation, Path Modification/Alteration, Path Not Available and Path Utilisation.
- The Network Statement defines on each network when the Short Term Path Request period is applicable before the running of a train.
- As described Short Term Path Request processes, for Short Term Planning, have been further extended to include Long Term Planning processes for the Annual

---

<sup>33</sup> The two communicating parties are sender and receiver of the messages. The bilateral exchange could involve all parties relevant for the harmonization. E.g. RU1 to IM1, IM2 to RU2 etc



Timetable (working timetable). Where there is information in the Planning section that is applicable to both processes, only Short Term Planning will be mentioned even though it could apply to Long Term Planning as well. Where there is information that is only applicable to one process and not the other, it will be specifically mentioned which process it is applicable to.

- The application of Short Term Path Request is mandatory according to TAP and TAF. The application of the same messages for Annual Timetable/Long Term Planning is optional.
- It is assumed that all activities described within the processes that are carried out by each IM are done so in accordance with their Network Statement.
- Even if based on the fulfilment of TAF/TAP regulation, there might be the possibility that 'Short-Term Path Request' processes will not be applied and companies will be able to follow their national practices and regulations. This will be in the case of exceptional transport such as the planning of nuclear or military trains. This will have to be decided by the authorities that determine the national practices and regulations.
- Activities of third parties (e.g. for shunting), acting on behalf of an RU or IM, have to be dealt by the responsible RU or IM who mandate the third party to handle the task(s). There will be no requirement for these third parties to be TAF/TAP compliant, responsibility lies within the mandating company
- Where there is a change of an RU in the operation, the responsible RU may use the resources (rolling stock/staff) of another company (e.g. RU). Responsibility and path ownership stay at the RU with the path contract. This has no impact to the regulation.
- TAF regulation applies to interoperable traffic across different networks whereas TAP regulation applies to both interoperable traffic and domestic traffic e.g. where there is just one RU and one IM involved in the path request.
- In relation to this document the term IM refers to an IM or an Allocation Body (AB) that carries out the same function as an IM.
- The term Path Section is used to describe a specific network section where there is an interoperable journey, however it also refers to a journey that is within one network.
- If the IM is the owner of the transport (e.g. maintenance train) it will carry out the same role as an RU and all processes will then be applied as normal.

### **13.3 Explanation on the involvement of the RUs and IMs**

The principle of TAP and TAF regulation are underpinned by the communication and collaborative relationship between an RU and the relevant IM. For interoperable business this usually involves more than one RU and/or IM involved during the different sections of the path request. However for domestic business the relationship can be between one IM and one RU only as well.

The diagram demonstrates the different types of relationships that the processes will apply to.

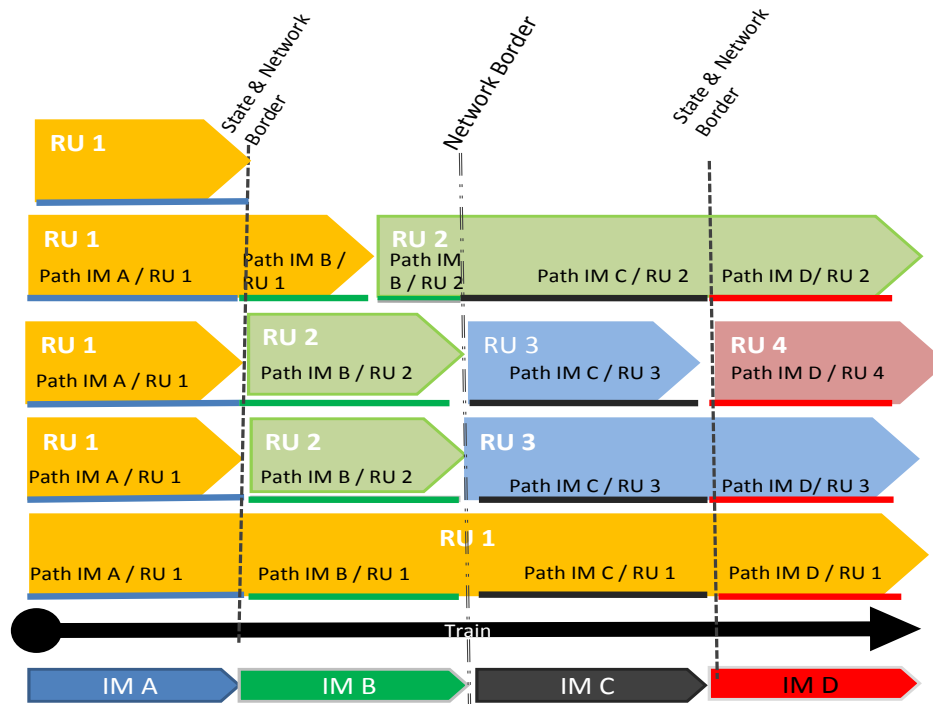

### 13.4 Summary of the outputs

A list of the main content is shown in the following table. The content of these can be accessed in the Annex 12.

Outputs Produced	Reference to Regulation / Comments
<b>Business processes (diagrams and descriptions)</b>	<b>Specific Section</b>
PATH REQUESTs	TAF 4.2.2 / TAP 4.2.17
Cooperation model ⇒ full harmonisation	Note that harmonization is not described in TAF
Cooperation model ⇒ partial harmonisation	
Open Access (single RU) ⇒ full harmonisation by IMs	
Open Access (single RU) ⇒ partial harmonisation by IMs	
Path requests via an OSS	
Path cancellation by RU ⇒ applicable to Cooperation and Open Access models	TAF 4.2.2 / TAP 4.2.17

## European Railway Agency

ERA/TD/2012-11/INT Annex B.56 of TAP TSI

Path alteration by IM	TAF 4.2.2 / TAP 4.2.17
Utilisation notification	Not enforced by the TSIs
Path modification by RU	TAF 4.2.2 / TAP 4.2.17
Working timetable ⇒ Long Term Planning	TAF 4.2.2 / TAP 4.2.17
Incident path management process	TAF 4.2.2 / TAP 4.2.17
<b>Messages</b>	<b>Reference or New</b>
Path Request	TAF ANNEX D.2 : APPENDIX F / TAP B.30
Path Details	TAF ANNEX D.2 : APPENDIX F / TAP B.30
Path Confirmed (Modified)	TAF ANNEX D.2 : APPENDIX F / TAP B.30
Path Details Refused (Modified)	TAF ANNEX D.2 : APPENDIX F / TAP B.30
Path Cancelled (Modified)	TAF ANNEX D.2 : APPENDIX F / TAP B.30
Path Not Available (Modified)	TAF ANNEX D.2 : APPENDIX F / TAP B.30
Receipt Confirmation	TAF ANNEX D.2 : APPENDIX F / TAP B.30
Dossier Location <sup>34</sup>	Not enforced by the TSIs
Dossier Section <sup>35</sup>	Not enforced by the TSIs
Answer not possible <sup>36</sup>	Not enforced by the TSIs
Utilisation notification <sup>37</sup>	Not enforced by the TSIs

In addition to the messages and processes code lists have been developed to support the data exchange. See chapter 11.

<sup>34</sup> Waiting approval by Change Control Management

<sup>35</sup> Waiting approval by Change Control Management

<sup>36</sup> Waiting approval by Change Control Management

<sup>37</sup> Waiting approval by Change Control Management

### 13.5 Processes

#### 13.5.1 High Level Overview of the Process

The purpose of implementing TAF/TAP TSIs is to ensure an efficient and concrete exchange of information between IMs, Allocation Bodies, RUs and other service providers. The exchange of information is done in relation to the processes during the planning stage.

This information exchange is essentially bi-lateral and takes place between the IM in charge of the Path Section and the RU that will operate over the Path Section. In the case of an Open Access Operator the RU will be dealing with several IMs.

The processes that make up the ‘Short-Term Path Request’ and the “Long Term Path Request”, known as the Working Timetable are shown as a high level overview. The TAF/TAP messages that need to be produced are overlaid onto the process activities that take place.<sup>38</sup>

#### Dialogs between RU and IM in Short-Term Path Request process with messages and IT status, Without Harmonization

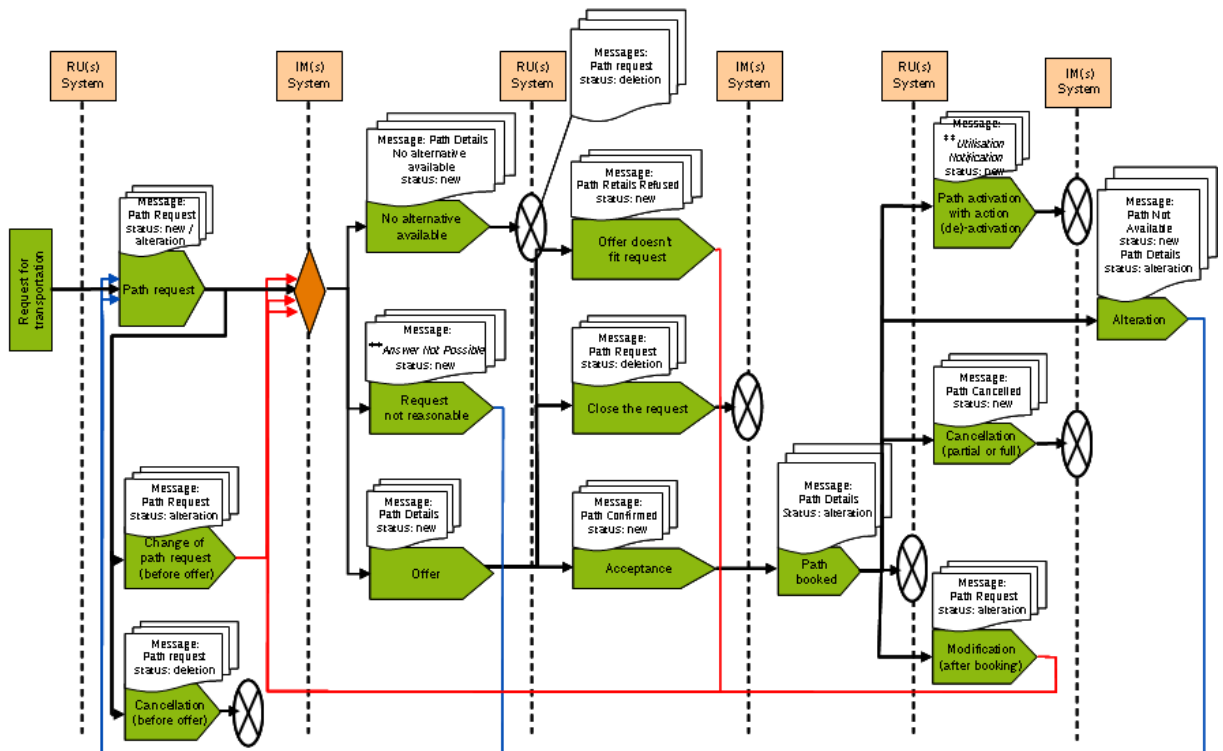

<sup>38</sup> (\*\*) Note that elements marked with two stars are waiting approval by Change Control Management

**Dialogs between RU and IM in Short-Term Path Request process with messages and IT status, With Harmonization**

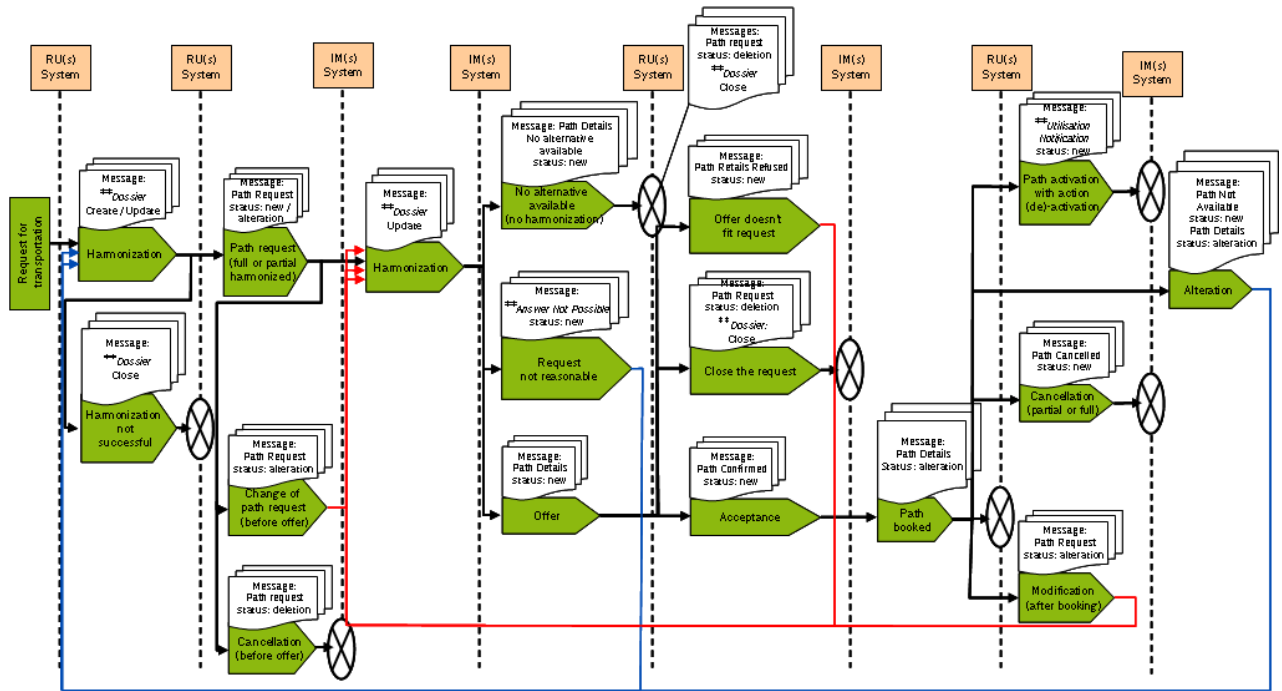

**Dialogs between RU and IM in Annual Timetable process (Working Timetable) with messages and IT status, With Harmonization**

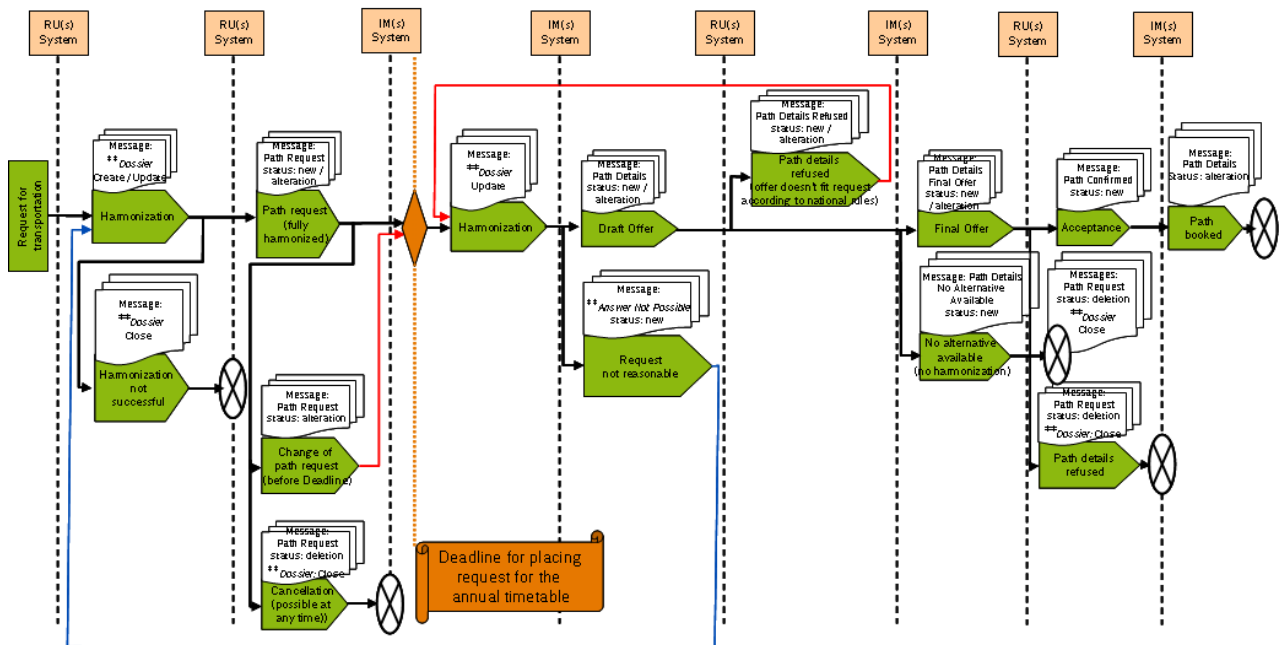

**Dialogs between RU and IM in Annual Timetable process (Working Timetable) with messages and IT status, With Harmonization**

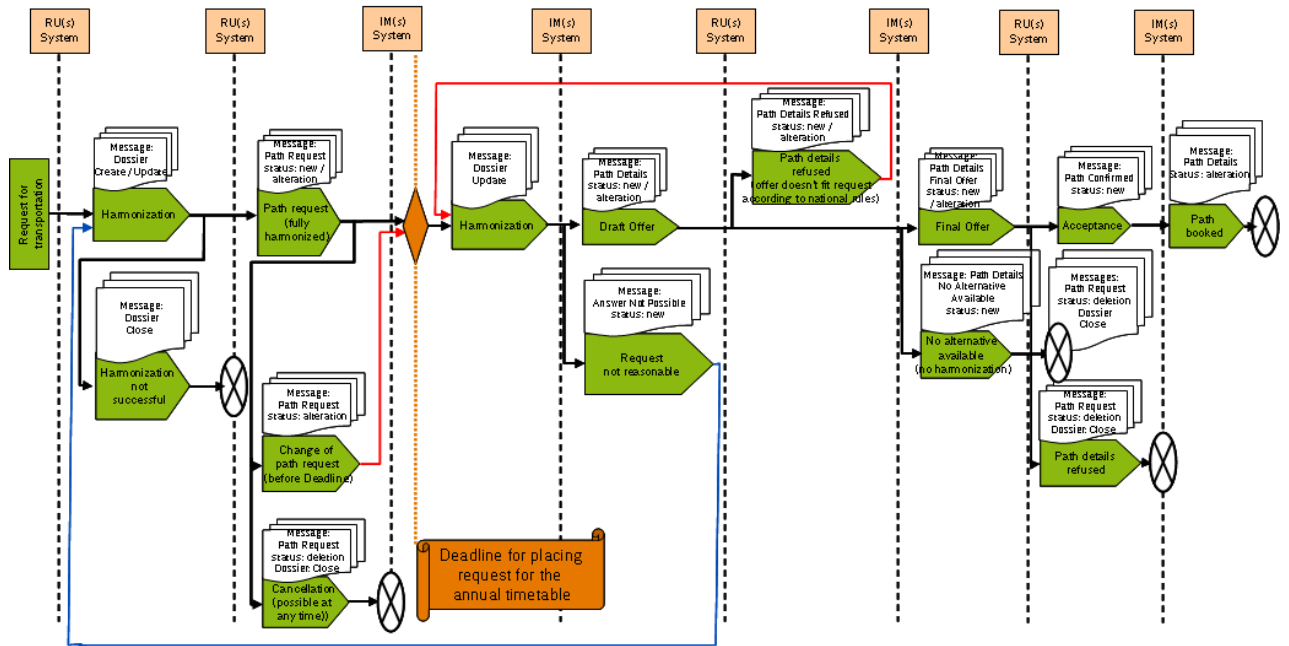

**Dialogs between RU and IM in Annual Timetable process (Working Timetable) with messages and IT status, Without Harmonization**

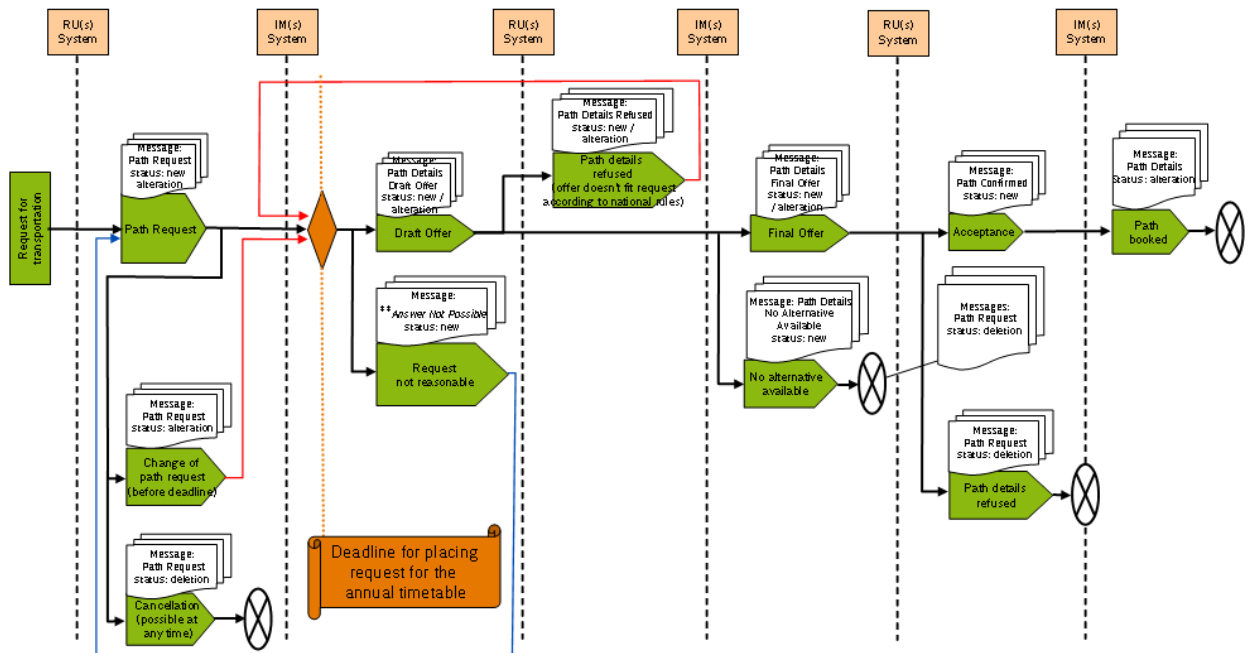

### 13.6 The need for Full and Partial Harmonization

Where a short-term path request for traffic (either passenger or freight) running across one or more networks is placed in sufficient time ahead of the operation, the IMs will be able to deliver **full harmonisation** for the path details for all of the sections that comprise the whole journey. Full harmonisation is when the complete journey for the traffic, covering all of the respective path sections, has been able to be fully validated by the IMs involved and all times are confirmed, especially those where the train changes from one IM to another.

Where a path request is placed at the short notice or if the complexity of the path request requires more time than anticipated (according to the deadlines set in their national agreements), the IMs will not be able to coordinate all of the sections for the whole journey. In this case the RU(s) will receive path details from the IM which are just coordinated with the next neighbouring IM only ensuring that the train travel across that section. In addition, if the RUs are not in a position to coordinate the request, (e.g. do not have resources for the request because of the short notice) the Lead RU<sup>39</sup> or the RU at the beginning of the traffic may place a partially harmonised request. In this case the first IM/RU pair is able to start working on the request; the following IM/RU pair(s) will follow as soon as the request is ready for the next path section. The request is handled more sequentially and it is not necessary that all the latter sections have been confirmed before that train sets off across its journey. This is called **partial harmonisation**.

There are separate path request processes for the two types of harmonisation.

In some cases a request for traffic starts off with the aim of carry out a fully harmonised process and it may be necessary, for whatever reason, to switch from full to partial harmonisation processes. By default the aim of harmonisation is to achieve a full harmonisation of the journey (all path sections), as represented in the Message (Path Request or Path Details) by two separate elements “Type of RU Harmonisation” and “Type of IM Harmonization”.

If this is the case the Lead RU or Coordinating IM sets the Type of Harmonisation to Full. However this is not possible in all cases and can subsequently be changed to Partial. For example if the Lead RU realises that it will not be possible to harmonise the path request with all other involved RUs in due time (e.g. RU at the end of the journey has not clarified the appropriate need for resources), the Lead RU shall have the possibility to change the element ‘*Type of RU Harmonisation*’ in the message Path Request from ‘full’ to ‘partial’.

On the other hand, it could happen that the IMs are not in a position to send harmonised path details to the RU (in case of an Open Access request) or to all involved RUs (cooperation model) in due time. This could be for example in a case where there is a shortage of time between placing the request involving several networks and the foreseen departure time at the origin of the train. The Coordinating IM or as a default the IM at the first network of the train departure shall have the possibility to change the element ‘*Type of IM Harmonisation*’ in the message ‘Path Details’ from ‘full’ to ‘partial’.

---

<sup>39</sup> See chapter 7 for the different uses of the term “Lead RU” in TAF and TAP. In the following text, “Lead RU” is used to designate this RU/AP for TAP.

### 13.7 Path Request Scenarios

Several path request scenarios will be possible between the RU(s) and the IM(s) for interoperable passenger/freight traffic. A number of the most commonly scenarios are shown as follows:

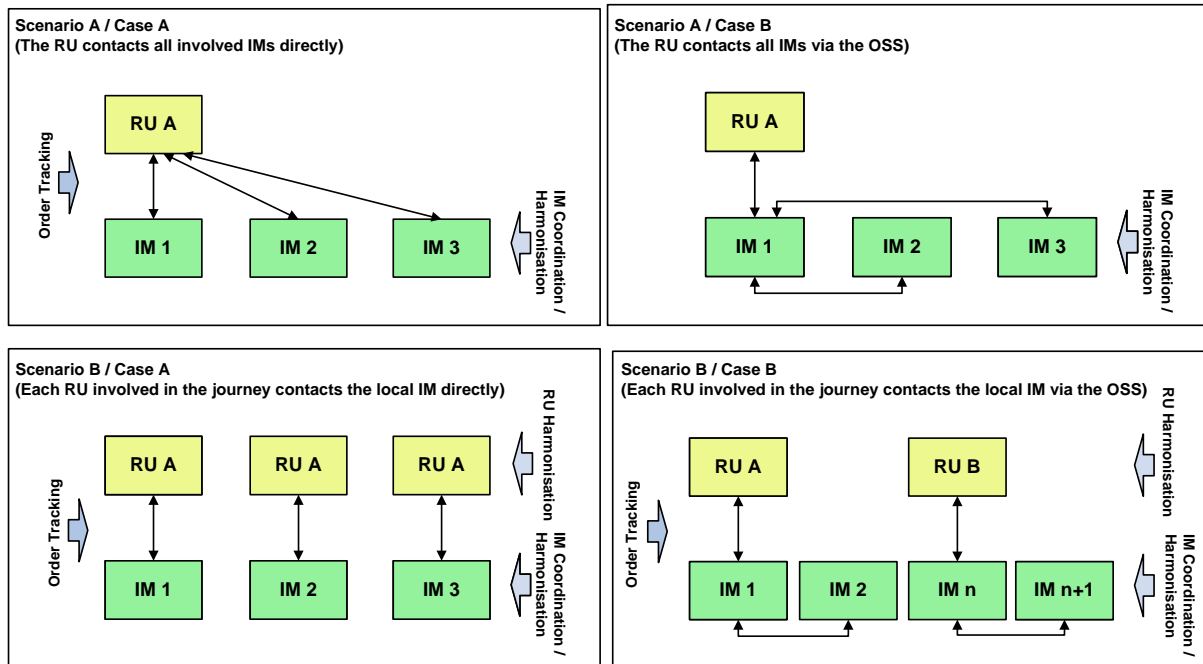

Scenario A (Case A/B) adheres to the Open Access business model whereby there is only one RU but several IMs involved throughout the journey. Scenario B (Case A/B) adheres to the Cooperation business model whereby more than one RU and IM are involved throughout the journey. These models are documented in the TAF Regulation 4.2.2.1

Note: These are not the only scenarios possible for interoperable traffic, in fact there can also be a combination of the above scenarios.

Also shown in the diagram is the need for coordination and harmonisation.

For some domestic traffic (applicable to the TAP regulation) where only one RU and IM will be involved therefore the scenario is very straightforward. Communication between the parties takes place at bilateral level which can basically seen as a sub-scenario of scenario A case A.

The scenario A covers the process when the RU contacts all the IMs involved. This can also be carried out without harmonization (e.g. through a central tool or in bilateral data exchange) between the different IMs. According to chapter 4.2.2.1 of TAF scenario A) defined in the following process, the AP contacts all involved IMs directly or via the OSS to organise the paths for the complete journey. In this case the RU has also to operate the train on the complete journey according to Article 13 of the Directive 2001/14/EC.



### **13.8 Short Term Path Request process**

The Short Term Path Request process (TAP BP 4.2.17, TAF 4.2.2) is, in fact, made up of a number of different processes that cover the different activities that take place during the planning phase. Key to the activities is the actual placement and confirmation of the request itself. However after a path is booked other activities continue to take place such as modifying the path, cancelling the path for a number of days and even activating a path (as is the case in several networks). The main processes are:

<b>Process</b>	<b>Relevant for TAP and TAF</b>	<b>Outside the TAF or TAP regulation, but developed from best practise</b>
Path Request	X	
Path modification by an RU	X	
Path cancellation by RU	X	
Path alteration by IM	X	
Utilisation notification		X
Path Studies		X

In addition to the Short Term planning processes an extended process for carrying out the activities in Long Term planning for trains in the Working Timetable has been developed. Currently the use of this process and message exchange will have to be a recommendation outside of the legal requirements of TAF and TAP.

This section provides an overview to each of the processes that have been developed. Annex 12 describes the Short Term and Long Term planning processes, in terms of descriptions and diagrams, in more detail.

#### **13.8.1 Process “Short Term Path Request”**

This process is based on the steps and activities for Short Term planning.

The RU will place a request for the Path Section in the journey and the IM will offer the path back. Normally the RU will accept the offer and the path will be booked by the IM. However it could also be the case that the Path Request cannot be answered by the IM (due to technical or logical errors in the request itself). It is also possible that the RU refuses the offer. These possibilities are all described in the process descriptions and documents.

Two separate processes have been produced, one for each of the business models

- Cooperation model (where several RUs are involved with several IMs)
- Open Access (where one RU is involved with several IMs)

In the situation where there is a possibility to have harmonization between the IMs the harmonisation should be done according to the processes hereafter. In cases where this is not possible (e.g. due to a very short notice request), it is possible for the harmonization to be omitted.

### **13.8.2 Process “Short Term Path Request – Full Harmonization”**

This process is based on the steps and activities for Short Term planning.

All path sections must be harmonised and agreed between the involved RUs before requesting and all involved IMs before an offer can be made back to the RUs.

The RU will place a request for the Path Section in the journey and the IM will offer the path back. Normally the RU will accept the offer and the path will be booked by the IM. However it could also be the case that the Path Request cannot be answered by the IM (due to technical or logical errors in the request itself). It is also possible that the RU refuses the offer. These possibilities are all described in the process descriptions and documents.

Two separate processes have been produced, one for each of the business models

- Cooperation model (where several RUs are involved with several IMs)
- Open Access (where one RU is involved with several IMs)

### **13.8.3 Process «Short-Term Path Request partial harmonisation»**

This process is based on the steps and activities for Short Term planning for Full Harmonisation.

It might be that all path requests may not be able to be harmonised between the RUs and that the IMs will be in a position to always deliver harmonised path details. This is mostly in the case of very short Term Path Requests where the time limit between the path request and the train departure is too short and it is not possible to harmonise the path request and/or path details. This process may be applied for the following business models:

Two separate processes have been produced, one for each of the business models

- Cooperation model (where several RUs are involved with several IMs)
- Open Access (where one RU is involved with several IMs)

### **13.8.4 Process «Path cancellation by RU»**

This process applies to both trains in the Working Timetable and those booked using the Short term planning process.

Whether the path was booked in the long-term planning (working timetable) or as a short request, the RU must have always the possibility to cancel a booked path. This path cancellation may refer to one single day, several or all remaining days. It is also possible to cancel the whole traffic (all of the path sections) or just one or more partial sections of the traffic (one path section).

However in case there are several path sections with RUs involved, it may even be possible that one of the involved RUs may keep its booked path section and reuse it for another train. By doing so, the path modification process shall be applied instead for the RU that still wishes to use the path section for other traffic.

### **13.8.5 Process «Path alteration by IM»**

This process applies to both trains in the Working Timetable and those booked using the Short term planning process.

Based on the path agreement, the RU can expect that a booked path is available up to its operation. However if an event occurs (e.g. disruption to the path) prior to the start of the operation and the booked path from either the long-term (working timetable) or short term planning is no longer available, the IM must inform the RU as soon as it has the knowledge about this fact.

A cause of the event (e.g. an interruption on the path) needs to be indicated to the RU. This can happen at any time between the moment the path is booked and the departure of the train. The IM is obliged to send an alternative proposal together with the indication the Path is not available. However this is not always possible to, if that is the case the IM must send the proposal as soon as possible.

This path alteration may refer to one single day, several or all remaining days. It is also possible to alter the whole path section or just a part of it.

### **13.8.6 Process «Path modification by RU»»**

This process applies to both trains in the Working Timetable and those booked using the Short term planning process.

Based on the path agreement, the RU intends to change some elements of the train that could impact the path details after it has been booked. A modification can be done for one day, several or all remaining booked days. Modifications that need to be communicated are described in the Network Statement and could be for example:

- Change of engine type with same performance
- reduction in the train length/weight
- operational stop changes to technical stop

It is then up to the IM to decide whether the modification requested impacts the booked path or not. If the change does not impact the path then the IM responds back to the RU that no change is necessary. If the modification of the path can be done as a result of the change then the IM offers the modified path back to the RU. If the modification of the change cannot be done by the IM the RU is informed to cancel the path and place a new path request.

The consequence of this notification could be that the RU does no longer want to make the change to the train affecting the path and thereby keeps the original booked path untouched.

### **13.8.7 Process «Utilisation Notification by RU»**

This process applies to both trains in the Working Timetable and those booked using the Short term planning process.

In some networks it is possible to pre-book a path and it is called an 'on demand path". The capacity has been allocated to an RU who has to inform the IM in due time and prior to the operation on the utilisation of this path, meaning that the train should then be run operationally. This type of practice between RU and IM is mainly used in cases where an RU has regular transport needs but does not know when to make the path request e.g. due to fluctuations in business. All of the path information (e.g. period, origin location, route etc..) is built up in the On Demand Path and is treated in exactly the same way by the IM whereby a path is offered and subsequently booked.

### **13.8.8 The Need for Path Studies**

The intention of a path study is to support the RUs by the IMs while setting-up a path request in anticipation of placing the actual request. It allows the RU to get timings for its intended train service to be used in its planning before placing a path request. Path studies make a significant contribution to the efficiency of the path allocation process for the working timetable. These studies allow applicants' service plans to be checked for feasibility and, as necessary, taken through into the next stages of the planning process. It is used mainly in the working timetable but can also be applied for the running timetable. No separate process description has been considered for this. This is because the process is identical for a path request, except the last step of the booking the path will not be carried out by the IM.

The IM answer to a path study request before the timetable starts is never binding. If the path study had been placed within the running timetable, the legal status of an IM answer depends to company/national rules.

Path studies are in addition to TAF and TAP. It follows best practice from the sector and can be used with the TAP and TAF standards although it is not mandated by TAP and TAF.

## **13.9 Train Identifiers**

### **13.9.1 Identification of the train**

With the full implementation of TAP and TAF the messages used in the Short Term Path Request will need to follow the Train Identification convention that will be applied as mandatory. It is a composite set of identifiers that uses the following:

- Train ID - A unique ID provided by the RU that stays with train throughout the different planning activities and beyond into Operation. The link between Path ID and Train ID is confirmed/fixed with the Path Confirmation Message.
- Path Request ID – A unique ID provided by the RU when making the path request (staying on through the whole booking process)
- Path ID - A unique ID provided by the IM when offering a requested path
- Case Reference ID – A unique ID that can be used to identify business cases that cover one or more trains that have been requested and can be used by both the RU and IM. For example an RU requests a regular set services for a train travelling A – Z and then Z – A. The RU uses one single Case Reference ID for both services but there will be two separate trains, one for A – Z and another for Z - A

Currently TAF/TAP regulation does not stipulate the use the Train Identifiers as mandatory for the initial implementation. However provision has been made in the planning messages to allow the use of all or part of the composite identifier. It is therefore possible, that for the initial implementation and up to the point where the use of Train Identifiers becomes mandatory, to use tailored identifiers as defined by the Stakeholders and represented in the TAF and TAP message catalogues.

The use of the 'Operational Train Number' as an identifier during the planning phase will be possible for use as by an RU or IM for train identification until the proposed structure of the Train Identifiers has been implemented as a mandatory requirement.

For some Stakeholders the initial implementation may see them using a combination of the Train Identifiers and OTN as per their national regulations relating to train identification.

Further details on the aims and usage of the different identifiers throughout the different processes are explained in more detail in Section 8 of this document, where also the link to the description of the TrainID is made.

### **13.9.2 Related Trains as Part of Train Identification Section**

Within the Train Identification Section there are elements that are able to identify other trains that are related to the train in the Message itself. This is to show the relationship for business activities that are related to the train identified in the path request. This includes for example the following scenarios:

- identifying the train with an earlier request e.g. a path study

- identifying connecting services.

These elements are held in the Train Identification Section of the Message and can be identified with a prefix e.g. “Related to other ...”. They are used as follows

- ...Case reference IDs - the path request is related to the case reference of one or more other trains that are related
- ... Planned Train ID – the path request is related to one or more single trains
- ... Path IDs – the path request is related to one or more (other) specific path
- ... Path Request ID – the path request is related to another (earlier) path request

### **13.9.3 Related Trains as Part of Train Activity**

It is also possible to include other trains identifiers in a Message based on a relationship as a result of a specific train activity. Within the Train Activity section it is possible to identify one or more trains as a result of specific activities that can take place on a location within the schedule.

If the Activity Code is related to another train, then one or both of the elements “associatedTrID” and/or “associatedOTN” (that is relevant for the transition to TrID) will need to be completed.

For example it is possible to identify another train that are related to the main train as a result of an attach / detach train activity that can take place at a specific train location.

## **13.10 Messages for Short Term Path Request**

### **13.10.1 General remarks to all Messages**

- An error (as defined by the codes used for Answer Not Possible message) identified for an optional element will have to be treated in the same way as an error for mandatory element. It will have to be corrected and then resubmitted following the normal process if required.
- A message may contain an indication. This is driven from the business context point of view in order to inform the recipient of this message regarding the consequence of the process activity that has just taken place (e.g. ‘No alternative available’ in the message ‘path details’).
- All messages have an element that identifies its current status (‘new’, ‘alteration’, ‘deletion’). This status is generated and subsequently updated only by the system as a result of process activity step that has taken place (e.g. ‘Alteration’ in the case when the RU changes a train parameter in the message ‘path request’ and re-submits the request).

### **13.10.2 Structure of the Message**

This section aims to give a brief overview of the main message elements:

#### **Message header**

The message header is common for all RU/IM messages and therefore has no business relevance related to Short Term Planning process. It is purely a technical part of the message. See chapter 12.

#### **Identifier**

This element group holds the Train ID and its composite Identifiers for the train as described in the message and any other related train that interacts with e.g. related train could well be another train that is attached to the main train during its journey.

#### **Train information**

This element group is used to facilitate the harmonisation between the involved RUs, IMs and to be used for information publication needs. The train information element contains the following information related to the train

- Schedule for the entire journey which includes all the key locations (Origin, final destination, interchange, handover, points with commercial stops) and their timings and activities.
- Reference Point which identifies the point from which the train needs to be planned to/from incorporating a calendar that describes the operational period (Start / From Dates) and its operational pattern (days on which the train runs)
- It is not always at the origin of a train run where the path planning starts. It may happen that an RU received a specific slot in a terminal at the final destination. In this case, the path planning is done backwards. The planning could also start in an interchange point in the middle of the journey based on an optimal engine circulation program. Therefore the (lead) RU has the possibility to choose the start of the path planning.
- planned train technical data which refers to the composition of the train and other technical parameters for the entire journey from the origin of the train until its final destination and the eventual change of composition and/or technical parameters during the run of the train. This is used for harmonization and information. The technical parameters for the path construction are derived from the Path Information Section.

#### **Path information**

This element group is used as a mechanism of communication by the RU and IM which holds the details from RU for each Path section or offered/booked journey section from one IM. The journey section starts at the origin of the train or at the handover point between IM's and ends at final destination or at the next handover point. This consists of all points that are specific to the Path Section (e.g. Station Stops, Run Throughs, Handover Points).

The data in the Path Information section is used to construct the path (from Path Request) and to inform about the offered data (in Path Details).

The structure is the same as that for the train information, except instead of holding another version of the calendar in its message, date-time offsets are used against the calendar used in at the Reference Point Location (Path Planning Reference Location in Train Information). The Path Planning Reference Location is only in Train Information Section.

### **Status of Harmonisation**

This element identifies the type of harmonisation (Full, Partial). A dossier (especially path request and/or path details) may be fully or partially harmonised. This attribute indicates the relevant status.

In case of just one single RU and one IM where the train is travelling in one network only, either “full” or “none” can be used, but not “partially”.

### **On Demand Paths**

This element refers to the allocating of pre-arranged paths.

### **Operational Train Number (OTN)**

This element, OTN, is given by the IM to the RU as soon as the foreseen OTN is known, at the latest before operation (before train preparation phase) by updating the message “Path Details” (status “alteration”). In some networks it can be provided beforehand by the RU as part of the Path Request in conjunction with the IM.

### **Network Specific Parameters section**

This element group may be used for specific attributes which are not mandatory on all networks and can be used bilaterally by the RU and IM. This element group should only be used between an RU/IM on a national section when it is absolutely necessary and where no common element in the main message can be identified. Otherwise there is a danger that the RU/IM could start using elements in this group and not use the elements from the common sections.

Before a company creates a Network Specific Parameter element it is required that the company checks the use of the element with the governance entity and its relevant work groups who will advise them if no common element can be created. See also chapter 24.

### **Affected Section**

This element group will be applied only in case of planning activities related to the full or partial path cancellation, alteration or utilisation notification of a path section.

Affected section is a part of the path and it's defined by the start point of section (first point) and the end point of section (last point) and is effectively used for identifying a specific train that is within a section.



**12.11. Overview of the messages**

This section aims to give a brief overview of the messages, in particular showing the status of the message as governed by the process activities

<b>Message</b>	<b>Relevant for TAP and TAF</b>	<b>Outside the TAF or TAP regulation, but recommended; developed from best practise in the rail sector</b>
Path Request	X	
Path Details	X	
Path Confirmed	X	
Path Details Refused	X	
Path Cancelled	X	
Path Not Available	X	
Dossier <sup>40</sup>		X
Answer Not Possible <sup>41</sup>		X
Utilisation notification <sup>42</sup>		X
Receipt Confirmation	X	

**13.10.3 Message ‘Path Request’**

This message is used for the following actions:

- original path request from RU to IM with status ‘new’
- path request with status ‘deletion’ in case the request is withdrawn
- path request with status ‘alteration’ in case the RUs wants to modify an element

**13.10.4 Message ‘Path Details’**

This message is used for the following action(s):

- path details from IM to RU with status ‘new’ for an indication ‘offered’ (this includes draft offer, final offer). If a draft offer turns into the final offer the status of the message will be alteration with an indication “Final offer”.
- path details message with status ‘new’ for an indication ‘no alternatives available’
- path details message with status ‘new’ for an indication ‘booked’
- path details message with status ‘alteration’ for an indication (e.g. type of answer = booked)
- The final Path Details message contains all data needed for the train run, i.e. the timing at all operational points along the trains journey.

**13.10.5 Message ‘Path Confirmed’**

This message is used for the following action:

<sup>40</sup> Waiting approval by Change Control Management

<sup>41</sup> Waiting approval by Change Control Management

<sup>42</sup> Waiting approval by Change Control Management

- path confirmation from RU to IM with status 'new'

#### **13.10.6 Message 'Path Details Refused'**

This message is used for the following action:

- refusal of path details from the RU to IM with status 'new'
- refusal of path details from the RU to IM with status 'alteration' if it refers to an alternative

#### **13.10.7 Message 'Path Cancelled'**

This message is used for the following action:

- (partial or full) path cancellation from RU to IM with status 'new'
- (partial or full) path cancellation from RU to IM with status 'alteration', if just a partial cancellation had been sent at the beginning

#### **13.10.8 Message 'Path Not Available'**

This message is used for the following action:

- booked path not available from IM to RU with status 'new'

#### **13.10.9 Message 'Dossier' (Dossier Location and Dossier Section)**

This message is in addition to TAF and TAP. It follows best practice from the sector and is therefore recommended although it is not mandated by TAP and TAF. It is used for the following actions:

- Holds the elements related to the Short Term Path Request process in the dossier with status 'new', 'alteration' or 'deletion' (new, modified, removed)
- Two Dossiers – "Dossier Location" and "Dossier Section"
- Dossier Location is linked with the messages - Path Request, Answer Not Possible, Path Details, Path Confirmed, Answer Not Possible - and holds the information related to train passing each of the locations of the entire train journey or the path section
- Dossier Section is linked with the messages Path Cancellation, Path Not Available, Utilisation Notification - and holds information related to train either for the entire path section or part of the section

#### **13.10.10 Message 'Answer Not Possible'**

This message follows best practice from the sector and is therefore recommended although it is not mandated by TAP and TAF. It is used for the following action:

- answer not possible with status 'new' in cases an IM receives an RU message where elements are wrong or missing (e.g. wrong addressee, no path details; mandatory elements missing, etc.).
- The appropriate message element is the "PathDossierError" and has a defined coding structure

### **13.10.11 Message 'Utilisation notification'**

This message is in addition to TAF and TAP. It follows best practice from the sector and is therefore recommended although it is not mandated by TAP and TAF. It is used for the following action:

- RU requests to the IM to activate or de-active a path with message element "Type of information" and code for "utilisation notification"

Some networks offer the possibility to book an optional path in advance. This means, that capacity has been allocated to an RU who has to activate it in order to run the train or to de-activate in case the train is not running.

### **13.10.12 Message 'Receipt Confirmation'**

According to TAF and TAP this message should be sent from the recipient of the message to the originator of the message in order to acknowledge that its legacy system has received the message.

This is required for specific business purposes where it is important to know at which point in time does the message arrive at receiving systems e.g. when a path request reaches a legacy system of an IM it has five days to plan and offer back the train.

## **13.11 Elements specific to stakeholders**

Key element data of the RUs, the content as for example train parameters, commercial information, cannot be changed by the IM or key element data of the IMs (e.g. received on time, maximum planned speed) by the RU. The data in these elements will be only passing through the messages and should not be allowed to be changed during the other stages of the process. However, it is practised today in some countries that in cases where there is no time to refuse an RU request that it is much easier to change train parameters by the IM, in accordance with the relevant RU.

A list of the key element data ownership can be seen in Annex 12.2.

It is up to the implementers to ensure that the mechanism of access control/validation is carried out according to their needs.

## **13.12 Business Scenarios**

This section provides specific real-life scenarios for a number of the different activities that take place during the planning phase. It shows how messages will be utilised during the communication between the RU and IM at the various stages of the scenarios.

In all examples described below the use of TrID / OTN will only be shown where there is a reference to other trains being involved within the scenario e.g. attach train. This is because this section aims to focus the reader on the scenario itself as opposed to how the scenario works together with train identification – these are covered in other TAF/TAP documentation such as the Handbook on Train Identification, referenced in chapter 9.

---

### 13.12.1 Ordinary train running across two IMs networks

#### Situation

Paths for a train are requested from A via B (commercial stop), C (no commercial stop but change of staff), D (change from IM a to IM b, run through only), to F. Location E is added by the IM as an additional operational location.

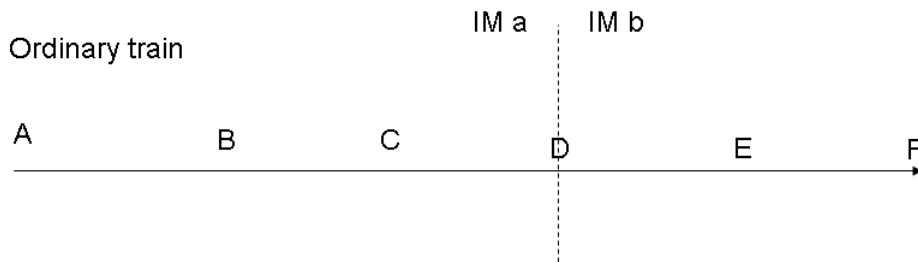

#### Preconditions

- Open access business model
- Handover point = Location D (which is a run through only)
- Location E is an additional run through location that is added by IM b to define the route and operational information
- Train composition is the same
- Change of crew at location C (Operational activity requested by the RU at the beginning)
- Information needs to be published as normal

#### Approach

The aim of this approach is to provide efficient RU/IM communication where a train is being requested to run across two different networks.

One approach for handling the RU and IM communication is described for this scenario and is explained as follows:

#### RU communicating with the IM

The RU sends one path request message to IMa for the section A – D. The path request message is sent with a Train Information section that contains all commercial stops (A,B,F), station C and handover point D. The path request message is sent with a Path Information section that contains Stations A, B, C, and Handover point D. In this scenario in the Path Information section it is also mandatory to enter the activity type code for 'Crew Change' at Location C. In the Train Information section it is optional for the RU to enter the activity type code for 'Crew Change' at Location C.

The RU sends one path request message to IMb for the section D - F. The path request message is sent with a Train Information section that contains all commercial stops (A, B, F), station C (where the train has to stop according to RU request) and handover point D. The path request message is sent with a Path Information section that contains Handover point D and Station F.

### **IM communicating with the RU**

IMa sends one path details message to the RU for the section A – D. The Path Details message is sent with a Train Information section that contains all commercial stops (A, B, F), station C and handover point D. The timings in the Train Information section are updated with the available times from the Path Information section. The Path Details message is sent with a Path Information section that contains Stations A, B, C, and Handover point D.

IMb sends one path details message to the RU for the section D - F. The path details message is sent with a Train Information section that contains all commercial stops (A, B, F), station C and handover point D. The timings in the Train Information section are updated with the available times from the Path Information section. The path details message is sent with a Path Information section that contains Handover point D , Station F and in addition Location E.

### **How it looks like in the message:**

An example is shown in Annex 12.3

### 13.12.2 Ordinary train running across two networks

#### Situation

Paths for a train are requested from A via B (commercial stop), C (no commercial stop but change of staff; RU interchange point), D (change from IMa to IMb, run through only), E (run through only) to F.

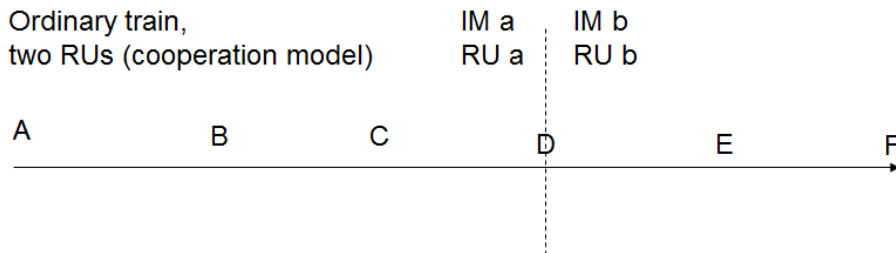

#### Preconditions:

- **Cooperation business model (2 RUs involved)**
- RUa takes the Lead RU role in this scenario
- There is a need for RU harmonization (not yet done e.g. in timetabling conference)
- RUb requests the run through Location E in the Path Request
- Handover point = D (run through only)
- Train Composition is the same
- Change of Crew at Location C (Interchange point; Operational Activity)
- Information needs to be published as normal

#### Approach

The aim of this approach is to provide efficient RU/IM communication where a train – operated by two cooperating RUs – is being requested to run across two different networks.

One approach for handling the RU and IM communication is described for this scenario and is explained as follows:

#### RU communication with cooperating RU

RUa (leading/coordinating RU) sends the “dossier location-based” message to RUb to start the harmonization between the RUs before placing a path request. This message is sent with a Train Information section that contains all commercial stops (A, B, F), station C, run through Location E and handover point D.

#### RU communicating with the IM

RUa sends one path request message to IMa for the section A – D. The path request message is sent with a Train Information section that contains all commercial stops (A, B, F), station C, run through Location E and handover point D. The path request message is sent with a Path Information section that contains Stations A, B, C, and Handover point D. In the Path Information section it is also mandatory to enter the activity type code for ‘Crew Change’ at Location C, if known. In the Train Information section it is optional for the RU to enter the activity type code for ‘Crew Change’ at Location C.

## European Railway Agency

ERA/TD/2012-11/INT Annex B.56 of TAP TSI

---

RUb sends one path request message to IMb for the section D - F. The path request message is sent with a Train Information section that contains all commercial stops (A,B,F), optionally station C, run through Location E and handover point D. The path request message is sent with a Path Information section that contains Handover point D, run through location E and Station F.

### **IM communicating with the RU**

IMa sends one path details message to RUa for the section A – D. The path details message is sent with a Train Information section that contains all commercial stops (A, B, F), station C, run through Location E and handover point D. The path details message is sent with a Path Information section that contains Stations A, B, C, and Handover point D.

IMb sends one path details message to RUb for the section D - F. The path details message is sent with a Train Information section that contains all commercial stops (A, B, F), station C, run through Location E and handover point D. The path details message is sent with a Path Information section that contains Handover point D, run through location E and Station F.

### **How it looks like in the message:**

An example is shown in Annex 12.3



### 13.12.3 Splitting of a train

#### Situation

Paths for a train are requested from A via B, C, D, E to F and Z. The train is formed of two portions (e.g. two train sets) running jointly from A to E. In E (commercial stop), the train is split: one portion continues to F, the other portion to Z.

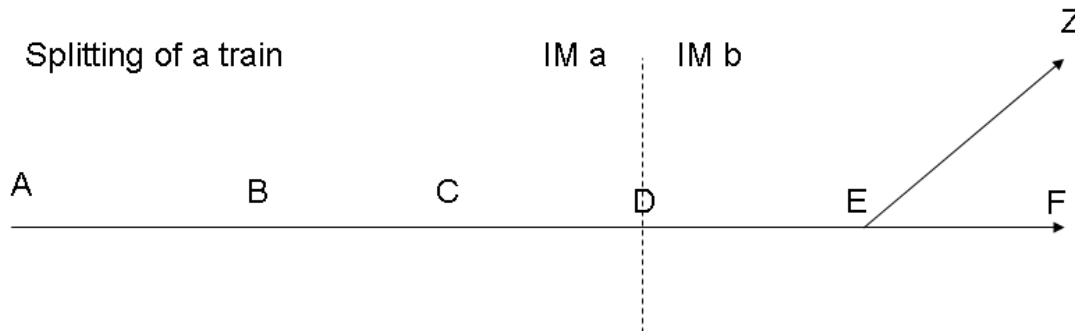

#### Preconditions

- Open Access business model
- Handover point = D (run through only)
- Train composition change and commercial stop in E.
- Location B, C are run through locations, requested by the RU
- Information needs to be published about the two trains and then the train split at Location E

#### Approach

The aim of the approach described below is to provide efficient RU/IM communication where a train is being split during its journey. There are many ways to communicate, however the simplest and most generic approach is to treat this scenario as two trains, the main train (A – F) and the second train (E – Z). This approach for handling the RU and IM is explained as follows:

#### RU communicating with the IM

The RU sends one path request message to IMa for the section A – D. The path request message is sent with a Train Information section that contains the commercial stops (A, E, F) and handover point D. The path request message is sent with a Path Information section that contains stations A, B, C and Handover point D.

The RU sends two path request messages to IMb for the section, one for the main train (A – F) and one for the second train (E – Z). The path request messages are sent with a Train Information section that contains the commercial stops (A, E, F) and handover point D for the main train and E and Z for the second train. For the main train the Path Information section contains stations E and F as well as the Handover point D. In the Path Information section it is also mandatory to enter the activity code for 'train split' at

## European Railway Agency

ERA/TD/2012-11/INT Annex B.56 of TAP TSI

---

Location E, while it is optional for the RU in the Train Information section. For the second train the Path Information section contains stations E and Z.

The two path requests sent to IMb should show the relationship between the two trains through the use of „associated/attached train“ code in location E.

IM communicating with the RU

IMa sends one path details message to the RU for the section A – D. The path details message is sent with a Train Information section that contains all commercial stops (A, E, F, Z) and handover point D. The path details message is sent with a Path Information section that contains stations A, B, C and Handover point D.

IMb sends two path details messages to the RU, one for the main train for section D – F and the other for the second train for section E – Z. The path request messages are sent with a Train Information section that contains all commercial stops (A, E, F) and handover point D for the main train and E and Z for the second train. For the main train the Path Information section contains stations E and F as well as the Handover point D. For the second train the Path Information section contains stations E and Z.

### **How it looks like in the message:**

An example is shown in Annex 12.3

### 13.12.4 Attaching of a train to another train

#### Situation

Two trains are running A – F, Y – F jointly coupled between B and F. The train is formed of two portions (two train sets) running jointly from B to F. Both parts run individually from A – B and Y - B. In B they are attached at the commercial stop, the trains are joined and become one train.

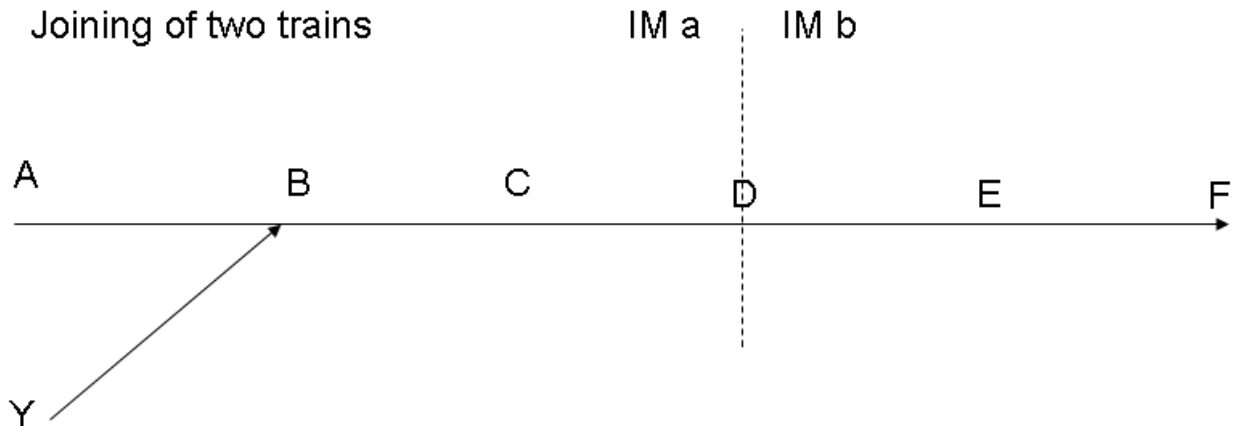

#### Preconditions

- Open Access business model
- Two Trains attach in Station B
- Location C is a run through location
- Handover point = D (run through only)
- Both Trains runs from B to F in one combined train-set
- Information needs to be published about the two trains attaching at Location B

#### Approach

The aim of the approach described below is to provide efficient RU/IM communication where two train sets are joining to create a combined train set for the rest of its journey. There are many ways to produce the efficient communication, however the simplest and most generic approach is to treat this scenario as two trains, the main train (A – F) and the attached train (Y – B). This approach for handling the RU and IM is explained as follows:

#### RU communicating with the IM

The RU sends two path request messages to IMa for section A - D, one for the main train (A – F) and the other for the attached train (Y – B). For the main train the path request messages is sent with a Train Information section that contains all commercial stops (A, B, C, E, F) and handover point D. The path request message for the main train (A – F) is sent with a Path Information section that contains stations A, B, C as well as the

## European Railway Agency

ERA/TD/2012-11/INT Annex B.56 of TAP TSI

---

Handover point D. In the Path Information section it is also mandatory to enter the activity type code for '0016 attach train' at Location B in the message for the section A – D, while it is optional for the RU in the Train Information section. The related train identifier/OTN (for the attached train) that will be attached at Location B will also be added into the Train Activity section.

For the attached train Y – B the path request message is sent with a Train Information and Path Information section of Y and B only. The related train identifier/OTN (for the main train) that the train will be attached to will also be added.

The RU sends one path request message to IMb for the section D - F. The path request message is sent with a Train Information section that contains all commercial stops (A, B, C, D, E, F) and handover point D. The path request message is sent with a Path Information section that contains station F and Handover point D.

### **IM communicating with the RU**

IMa sends two path details messages to the RU, one for the main train for section A – D and one for the second train Y – B. The path details message for the main train is sent with a Train Information section that contains all commercial stops (A, B, C, E, F) and handover point D. The path details message for the attached train is sent with a Train Information section that contains locations Y and B. The path details messages are sent with a Path Information section that contains A, B, C, D in the message for the main train and stations Y and B for the attached train.

IMb sends one path details message to the RU for the section D - F. The path details message is sent with a Train Information section that contains all commercial stops (A, B, C, E, F) and handover point D. The path details message is sent with a Path Information section that contains E and F and Handover point D.

### **How it looks like in the message:**

An example is shown in Annex 12.3

### 13.12.5 Trains with different routes on specific days

#### Situation

Paths for a train are requested from A via B, C, D, E to F. The train only runs on Sundays between A and B, but daily between B and F.

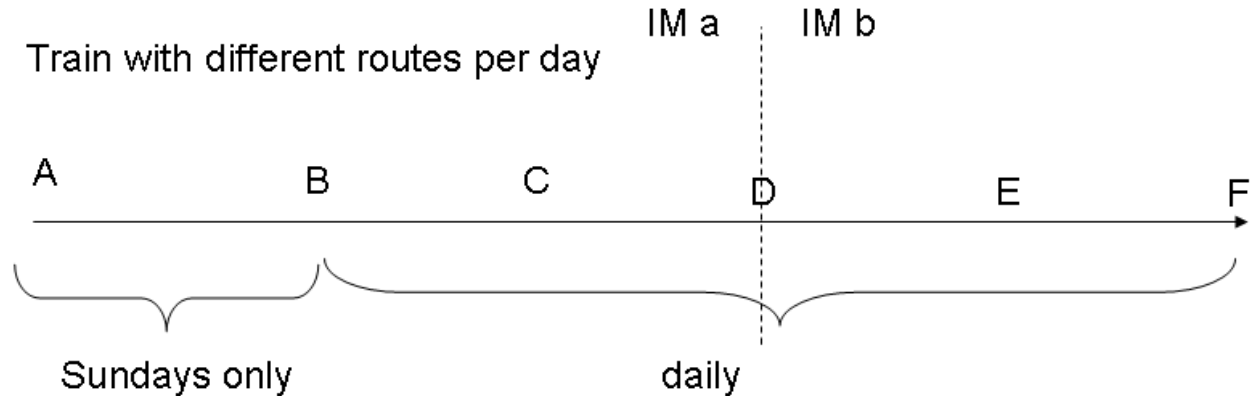

#### Preconditions

- Open Access business model
- Train Composition is the same for the different calendars
- No specific operational activities taking place
- Information needs to be published for the two trains

#### Approach

The aim of this approach is to provide efficient RU/IM communication where a train is being requested to run across two different networks for different running days and having extended locations on some of the days.

This approach is only one method of handling the RU and IM communication for this scenario. There are other approaches that can be implemented, e.g.

- Approach 1: Treated as two different trains with different calendars (A – F & B – F)
- Approach 2: Sunday train (A-B) linked with the daily train (B – F)

Approach 1 is described as follows:

#### RU communicating with the IM

The RU sends one path request message to IMa for the section A - D with a calendar element showing all Sundays and another path request message to IMa for the section B - D, with a calendar valid for all days except Sundays. The two path request messages are sent with different Train Information sections (A – F for the Sunday Train and B – F for the Daily except Sunday train). The two path request messages are sent with different Path Information sections (A – D for the Sunday Train and B – D for the Daily except Sunday train).

The RU sends one path request message to IMb for the Sunday train and another path request message for train running every day except Sunday. The two path request

## **European Railway Agency**

ERA/TD/2012-11/INT Annex B.56 of TAP TSI

---

messages are sent with different Train Information sections (A – F for the Sunday Train and B – F for the Daily except Sunday train). The messages are sent with the same content in the Path Section (D – F).

### **IM communicating with the RU**

IMa will send back two path details messages one for Daily except Sundays train (B – D) and one for Sunday (A – D)

IMb will send back two path details messages one for Mon – Sat (D – F) and one for Sunday (D - F). This could be the same path but could also be two different paths.

### **How it looks like in the message:**

An example is shown in Annex 12.3

**13.12.6 Change of a booked train for certain days (e.g. planned re-routing)**

**Situation**

Paths for a daily train have been booked from A via B, C, D, E to F. The booked train runs daily. The RU originally wishes commercial stops in A, B and F

During the running period of the train, closure of station B is necessary for one day on short notice. The train has to be re-routed via X and will leave earlier in A (relates to the process "Path alteration by IM").

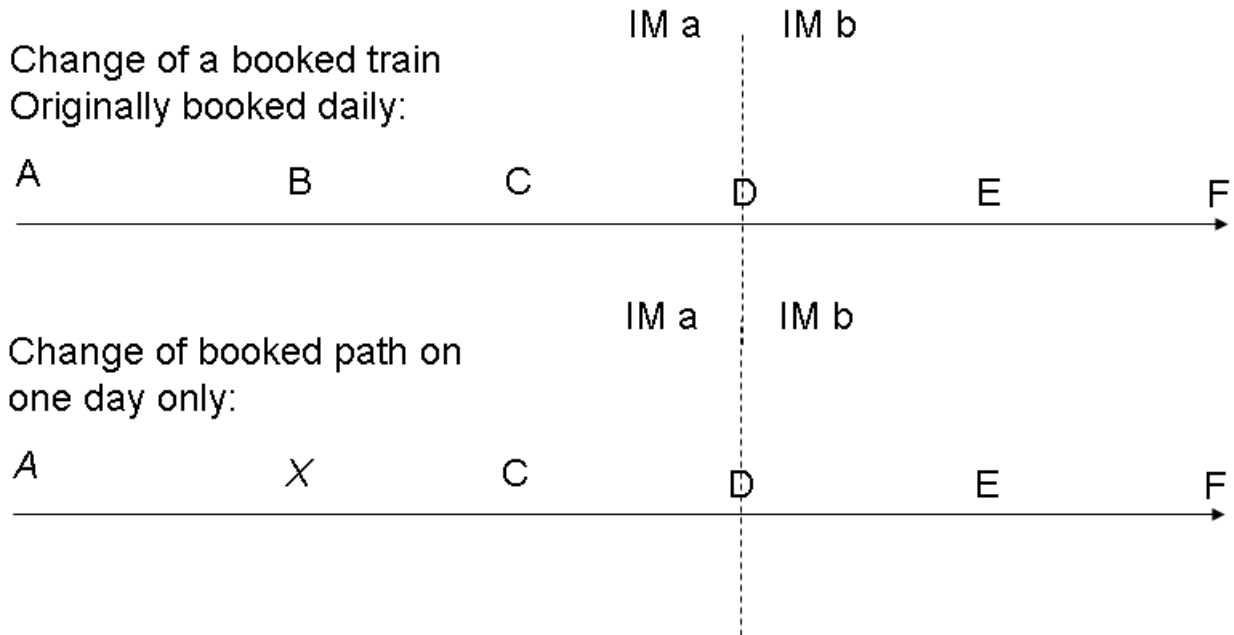

**Preconditions**

- Open Access business model
- Handover point = D (run through only)
- Standard RU/IM communication for the initial path booking
- Train Composition is the same
- Information needs to be published as normal
- Information will be updated after the disruption – Closure of Station B
- Closure of B is supposed to be known after the path request made by RU
- Closure of station B is supposed to be known before the sale of the tickets begins for the day of B closure
- The closure of Station B has no impact to the path of IM b

**Approach**

The aim of this approach is to provide efficient RU/IM communication where a train is being requested to run across two different networks for different running days and being rerouted one day.

One approach for handling the RU and IM communication is described for this scenario and is explained as follows:

**IM communicating with the RU**

When the closure of Station B is known IM a sends the Path Not Available message to RU informing that Station B will be closed for one day: The Affected Section includes the

## **European Railway Agency**

ERA/TD/2012-11/INT Annex B.56 of TAP TSI

---

Start of Section (A), End Section (D) and the Calendar which will be for the one day of closure

As soon as possible IMA sends an alternative Path Details message with Location X in the section (A – D) for the one day; any altered timings will also be included in the message

### **How it looks like in the message:**

An example is shown in Annex 12.3



### 13.12.7 Trains with Through Coaches

#### Situation

Paths are requested for a train A via B, C, D, E to F. Some coaches of the train are detached in E. These coaches are attached to another train from W via E to Z. Through coaches (coach groups) from A to Z are established.

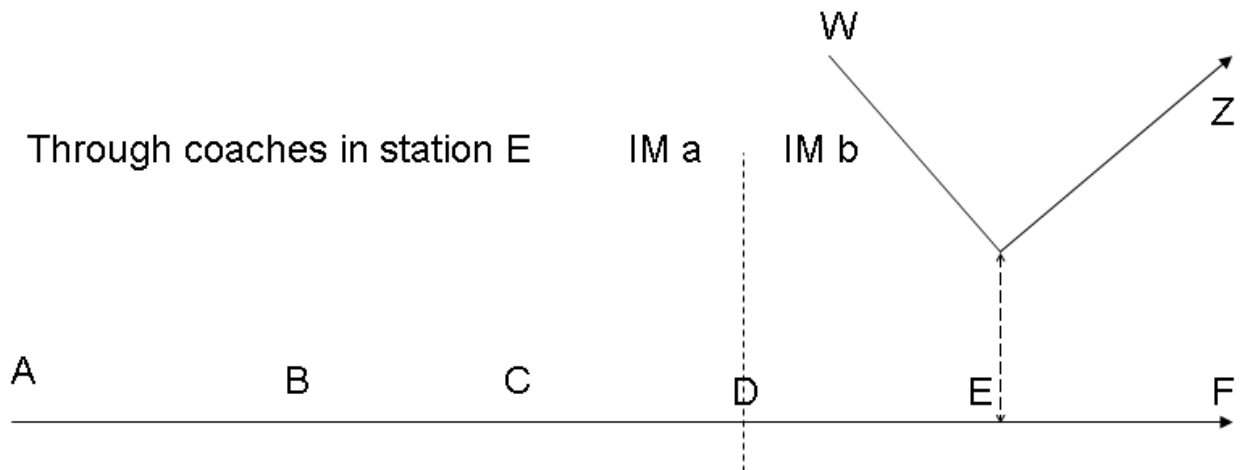

#### Preconditions

- Through coaches in a station of IMb
- Train W - Z a priori unknown from IMA
- Trains A - F and W - Z are nevertheless associated

#### Approach

The aim is to provide efficient RU/IM communication, where two different trains stop at the same station, in order that a coach is detached from one train and attached to a second train.

#### RU communicating with the IM:

A Path Request Message is sent by the RU to IMA. The Train Information contains the Activity Code at Location E “Detach Coach”.

A Path Request Message is sent by the RU to IMb for train (A – F). The Message has to indicate that a coach is detached in Location E via the Activity Code “Detach Coach”. The related Train Identifier/OTN on which the attached Coach will be added (train W – Z) at E will also be added into the Train Activity section.

The Path Request Message sent by the RU to IMb for the other train (W – Z) has to indicate that the train in station E receives a coach from train A - F (related Train Ids). The Message has to indicate that a coach is attached in Location E via the Activity Code “Attach Coach”. The related Train Identifier/OTN on which the attached coach came from (train A – F) at E will also be added into the Train Activity section.

**IM communicating with the RU:**

A Path Details Message is sent by the IMa back to the RU.

Two Path Details Messages are sent back by IMb to the RU. The Path Details Message is sent by the IMb back to the RU for Train A - F. The Message has to indicate the times at station E, and the Train Id/OTN of the train for which the coach is attached to (train W – Z). The Path Details Message is sent by the IMb back to the RU for Train W - Z. The Message has to indicate the times at station E and the Train ID/OTN of the train for which the coach is detached (train A – F).

**How it looks like in the message:**

An example is shown in Annex 12.3

**13.12.8 Trains that cannot leave before another train has arrived (diagram dependence)**

**Situation**

Paths are requested for two trains: A to F and F to A. The RU has to use the same physical train set, therefore, the second train cannot leave F before the first train has arrived in F.

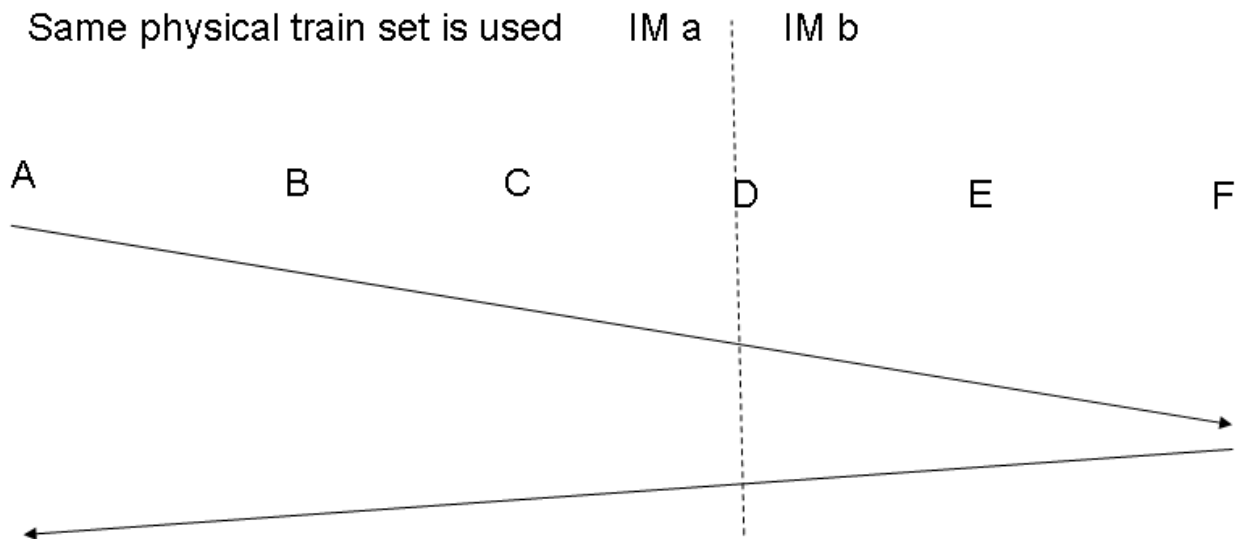

**Preconditions**

- Open Access business model
- Handover point = D (run through only)
- No commercial stops except A & F
- Train Composition is the same (same physical train set). RU requires the IM to take this into account.
- Considered as two different trains where Train A – F is planned before Train F – A
- Running days of train A – F are the same as for F - A

**Approach**

The aim of this approach is to provide efficient RU/IM communication where a train is being requested to run in one direction, known as the first train (A – F), and then the train runs again (as a different service) in the reverse direction, known as the next train (F – A).

One approach for handling the RU and IM communication is by showing train activities (Next Working) to link the two trains (including the use of related Train IDs/OTNs).

This scenario is explained as follows:

**RU communicating with the IM**

The RU sends one path request message to IM a for the path section A – D. The path request message is sent with a Train Information section contains commercial stops (A, F) and handover point D. At Location F, the train activity type code "Next Working" is entered, together with associated attached Train ID/OTN of the next train. The path request message is sent with a Path Information section that contains Commercial Stop A and handover point D.

The RU sends one path request message to IM b for the path section D - F. The path request message is sent with a Train Information section contains commercial stops (A, F) and handover point D. At Location F, the train activity type code "Next Working" is entered, together with associated attached associated attached Train ID/OTN of the next train. The path request message is sent with a Path Information section that contains Commercial Stop F and handover point D.

#### **IM communicating with the RU**

IMa sends one path details message to the RU for the section A – D. The path details message is sent with a Train Information section containing commercial stops (A,F), handover point D and for Location F the Train Activity Type, Next Working, with associated Train ID or OTN. The path details message is sent with a Path Information section that contains Commercial Stop A and handover point D.

IMb sends one path details message to the RU for the section D – F. The path details message is sent with a Train Information section containing commercial stops (A,F), handover point D and for Location F the Train Activity Type, Next Working, with associated Train ID or OTN. The path details message is sent with a Path Information section that contains Handover point D and Station F.

#### **How it looks like in the message:**

An example is shown in Annex 12.3

**13.12.9 Trains that need to be shunted from one platform to another at a location during the train run**

**Situation**

Paths for a train are requested from A via B to F. At B, the train needs to arrive at track 1 but has to leave from track 9. In reality, the train is shunting out of track 1 into track 9 and continues to the next station from track 9.

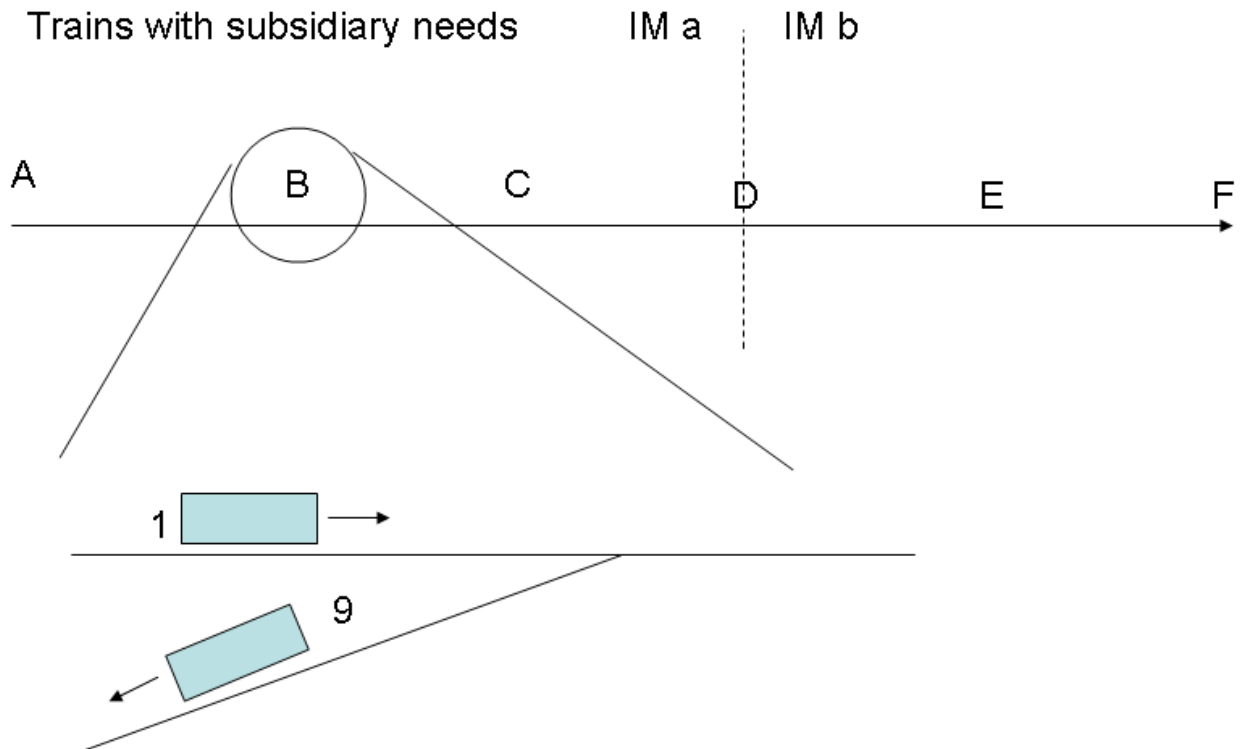

**Preconditions**

- one RU and two IM (IMa , IMb)
- assumption daily train
- unchanged composition in B
- train change platform because of track layout
- publication as through train
- Passengers can only alight on track 1 in location B

**Approach**

The aim of this approach is to provide efficient RU/IM communication where a train is being requested including shunting according to the track plan of station B and followed to run across two different networks

**RU communicating with the IM**

## European Railway Agency

ERA/TD/2012-11/INT Annex B.56 of TAP TSI

---

The following is just an example on how to handle the business scenario. Every solution is depending on national rules.

The RU sends one path request message to IMa for the section A – D with the path information section showing two subsidiary locations at B; one primary location with an attached subsidiary location at B showing track 1 (LS1) with an arrival and a departure time and the same primary location this time with a subsidiary location for track 9 (LS9) including a departure time. The train information section contains all commercial stops (A, B, C, D, E, F). There will be a Train Activity Type as a shunting operation for each location at B.

The path request message is sent for train running every day, else without any other difference.

The RU sends one path request message to IMb for train running every day from D – F.

The train information section contains all commercial stops (A, B, C, D, E, F). The path information section contains D, E, F as ordinary stops.

### **IM communicating with the RU**

IMa will send back one path details message for running every day from A to D, including both subsidiary locations at B (LS1 and LS 9) and their relevant times.

IMb will send back one path details message for D – F.

### **How it looks like in the message:**

An example is shown in Annex 12.3

### **13.13 Business rules**

This section provides the specific business rules/conditions on how specific elements within the messages will need to be applied for certain situations.

The business rules for applying the calendar are explained in 12.15.

#### **13.13.1 Train Weight/Train Length**

##### **Determining the Train Weight**

If the “Traction Weight” and the “Weight of the set of carriages” are both entered into the message, the “Train Weight” can be calculated as the sum of the two elements.

If the “Train Weight” and the “Weight of the set of carriages” are both entered into the message, the “Traction Weight” can be calculated as the difference of the two elements:  
Train Weight – Weight of the Set of Carriages

If the “Train Weight” and the “Traction Weight” are both entered into the message, the “Weight of the set of carriages” can be calculated as the difference of the two elements:  
Train Weight – Traction Weight

##### **Determining the Train Length**

Note: The element Length under the element group Traction Details denotes to the length of the Traction Unit. It is a global element that is reused in other Messages hence it is given the generic element name of Length

Note: The Length element will need to be entered in millimetres and will need to be converted on application level only to metres if it is used in the calculation.

If the “Length” and the “Length of the set of carriages” are both entered, the “Train Length” can be calculated as the sum of the two elements.

If the “Train Length” and the “Length of the set of carriages” are both entered into the message, the “Length” can be calculated as the difference of the two elements: Train Length – Length of the set of carriages

If the “Train Length” and the “Length” are both entered into the message, the “Length of the set of carriages” can be calculated as the difference of the two elements: Train Length – Length

Therefore as a general rule, at the application level, it will not be required to implement all three elements regarding the weight/length as mandatory elements in the XML. It might be left to the application to calculate one of the three elements – under the precondition that the two remaining elements are entered as mandatory.

### **13.13.2 Loco Type Number**

Currently there is no common coding for the European Loco Type. It can be assumed that each IM is familiar with the Loco Types and its characteristics of its registered customers (the RUs). Therefore, this element will be based on national basis, defined by each IM: However this element remains within main structure of the Message as opposed to being in the Network Specific Parameters section – this is because there is likely, at some point in time, to be a European Coding standard. It also serves to keep all traction details together in one section as opposed to splitting the information across the two sections.

The recommended usage of the 12 Alpha-numeric element is as follows:

- The first four digits: company code of engine operator
- The next 8 digits based on national/company rules (e.g. 218100001216 = RCA Taurus)

As there are various models for the ownership and usage of a loco, it is important that the RU which is operating the engine needs to be indicated.

### **13.13.3 Combined Traffic Load Profile<sup>43</sup>**

This element refers to combined load units that can be used for Freight Requests only.

There are two entry options:

- One option refers to “P” (Semi-trailer/road semi-trailer):  
P1 requires the code in case the gauge of the semi-trailer is  $\leq 2500$  mm.  
P2 requires the code in case the gauge of the semi-trailer is  $> 2500$  mm  $\leq 2600$  mm
- The other option refers to “C” (Swap body):  
C1 requires the code in case the gauge of the swap body is  $\leq 2550$  mm.  
C2 requires the code in case the gauge of the swap body is  $> 2550$  mm  $\leq 2600$  mm

The RUs may indicate the relevant values if they are familiar with the IMs line profiles. In case there is a path request for a train with combined traffic load, the IM should indicate in the Path Details Message the possible max. value for all 4 elements (P1, P2, C1, C2)

### **13.13.4 Highest planned speed and minimum break weight percentage**

Data elements that need to be entered into the Path Details Messages to keep them consistent on their structure referring to IM requirements and information towards the RU. Not to be used in the communication from RU to the IM but only when the IM communicates back to the RU.

---

<sup>43</sup> Waiting approval by Change Control Management



### **13.13.5 Braking weight and Minimum Brake Weight Percentage**

Braking Ratio value is entered by the RU in a Path Request whereas the MinBrakedWeightPercentage value is entered by the IM in the Path Details.

From a business perspective these elements must be referred to in terms of a % but have to be entered in the Message as a numeric integer value in the range from 1 up to 999 e.g. 11% will be entered as 11

### **13.13.6 Use of the Train Activity Type and Associated Trains**

The list of Activity Type Codes is split into two types: Common European Codes that are available to be used by all countries and National/Company codes that are only relevant to a specific network and to be used in the RU / IM communication only for that network. In both cases the element size will be 4 alpha-numeric.

Common European Codes will have the structure as follows:

- 4 Digit Code (numeric) that represents the Code List values for the common activities

National Codes will have the structure as follows:

- The first two characters will represent the country of the network in ISO format e.g. UK
- The remaining two characters (represented as a numeric) will represent a single unique activity within the network e.g. 01 = Stops shorter than 30 secs

See also chapter 13.9.3

### **13.13.7 Timing at location**

When placing a Path Request the RU enters the following times if the location is a stopping point (e.g. at station): Earliest or Latest or both time(s) for Arrival and/or Departure

When placing a Path Request the RU enter the following times if the location is a run through: Leave Arrival and Departure blank

When editing Path Details the IM enters the following times if the location is a stopping point (at station): Actual time(s) for Arrival and/or Departure

When editing Path Details the IM enters the following times if the location is a run through: Actual times for Arrival and Departure which must be same. In addition the IM must use the Activity Type Code for "Run Through".

### **13.13.8 Dwell Time**

The Dwell Time element is entered in the Path Request to include a required minimum waiting time of the train at a particular location. It is given in the format of a one decimal numeric value whereby the integer part of the value represents the time minutes and the decimal part of the value represents the time in seconds.

The integer value will be represented in minutes only, therefore any dwell time that is in hours (> 60mins) will need to be converted to minutes e.g. 3 hours dwell will need to be represented as 180

The decimal value will be required in all cases (even if there are no additional seconds). Each decimal value represents 6 seconds of time e.g. 0.1 = 6 secs, 0.2 = 12 secs etc... Any other value will have to be rounded to the nearest 6th second e.g. 16 secs will be rounded to 18 seconds and will be represented as 0.3

For example: A Dwell Time of 12mins & 28 seconds will need to be represented as a value 12.5

### **13.13.9 Received on Time<sup>44</sup>**

This element is only to be used for the Long Term planning purposes (for the annual timetable) in order to indicate whether a request has been made before the deadline day. For the annual timetable (working timetable), an RU may place a path request either on time (before the path request deadline) and can “benefit” from the procedure as described in EU Dir. 2001/14, Articles 20 & 21 or may place a late path request (after the path request deadline). In the second case, the request will be treated afterwards and based on remaining capacity. The IM must indicate if the path request was received on time. This is mainly a legal issue.

### **13.13.10 Status of RU/IM harmonization**

These two elements in this group identify the status of the harmonisation; Interchange harmonised or Handover harmonised – depending on RU or IM respectively.

If it is the Path Request Message from the RU this status reflects that the RU harmonisation has taken place (full or partial or none) in the element Status of RU Harmonization.

If it is the Path Details Message from the IM this status reflects that the IM harmonisation has taken place (full or partial or none) in the element Status of IM Harmonization.

Status of Harmonisation (Interchange & Handover) is a Global element – needs to be in all Messages within the Short Term Path Request processes.

---

<sup>44</sup> Waiting approval by Change Control Management

### **13.13.11 Use of Affected Section**

This element group will be applied mainly in case of planning activities related to full or partial path cancellation, alteration or utilisation notification of a path section to show the part of the train journey that has been impacted (= the affected section).

However before the implementation of the Train ID the Affected Section shall also be used to identify the train (resp. the request) up to the point that it is being booked. This is for the following messages - Path Confirmed (PC), Answer Not Possible (ANP) and Path Details Refused (PDR). The affected section is used to relate to the identification of the train in the earlier message(s) so it has to contain the same Train Number with the valid locations than in the earlier message(s). This is similar to the concept before implementation of Train ID described in chapter 9.

Affected section is defined as the first point of section (start point) and the End point of Section (last point). Until the Train ID is implemented, the effected section also includes the Train Number (optional afterwards).

### **13.13.12 Network Specific Parameters**

Network Specific parameters are defined by IM in accordance with national conditions/rules where there is no commonly agreed element that fulfils the same business purpose between the various stakeholders. The use of this shall be limited to the absolute necessary minimum.

For example the element "Network Specific Parameters" in the Affected Section can be used for RU to IM or IM to RU communication after the path had been booked. The IMs may use it in the "Path Not Available" Message

For example, a booked path refers to a train length of 620 m. For a specific period, the train length needs to be limited to 400 m. The RUs may use this element as agreed with the IM e.g. in the "Utilisation Notification" Message to indicate the train length of 400 m for the period the "Utilisation Notification" Message refers to.

### **13.13.13 Contact Detail**

The Sender of a message must have a phone number or E-Mail entered or both. Both are shown as Optional but one has to be completed and shown within the message.

### **13.13.14 Path Dossier Error<sup>45</sup>**

Where there is a problem with the Path Request and an “Answer Not Possible” message has to be used to communicate back to the RU by the IM, a Path Dossier Error code is required to be used in the message. There will be a Path Dossier Error code for each element where a problem has been identified. The error code for the element is obtained from the code list and is used to identify an invalid or missing element. In addition there is a possibility to provide additional text along with the predefined code, known as the Error text. The element can remain as blank, does not need to be completed for each Error Code.

The PathDossierError Codes have been structured so that it is possible to indicate there is an error with a specific element in the message or within the element group of the message. It can therefore be possible to populate the Answer Not Possible Message with specific errors or errors related to an element group. This will be done at the application level.

In addition, it is possible to enter a textural description of errors within the request message within the FreeText element that is also available. This can be for element specific errors but can also be extended to cover logical errors within the request, e.g. where the train locations do not make sense. Again this will have to be built at the application level.

The code list of Error Codes element is split into two types: Codes for the Common elements in the Message and codes that are only relevant to the elements within the Network Specific Parameters.

Common codes will have the structure as follows:

- 4 Digit Code starting from 5000

Network specific codes will have the structure as follows:

- 4 Digit Code starting from 6000

These will be national Error Codes related to elements entered into the Network Specific Parameters section that have been agreed by RU/IM and held and maintained on the IM system only. These are not required as a common list.

### **13.13.15 Type of Request**

The “Type of Request” element is needed to indicate which particular business process the RU is applying for. Indication of the request type is necessary for IMs to start the particular business process according to the type (study, or binding path request or modification of the existing contracted object). It is mandatory in Path Request and Path

---

<sup>45</sup> Waiting approval by Change Control Management

## **European Railway Agency**

ERA/TD/2012-11/INT Annex B.56 of TAP TSI

---

Details, but optional in Receipt Confirmation (as this just provides additional information about the process from which the receipt is required).

The “Type of Information” is used in several messages and are used several times for different purposes. Therefore the recipient has to know the status which indicates why the message was sent. To recognise to which process does this message fit, and also to which particular process step does this particular message have to be considered. It is Mandatory in Path Request, Path Details and Utilisation Notification, optional in Receipt Confirmation.

## **13.14 Application of the Calendar in the Message**

### **13.14.1 Overview of the Calendar**

There is a key business requirement to include a calendar into all of the STPR Messages that have been defined. The aim of the Calendar is to provide the recipient of the message with the necessary information on the operational status of the train either during the planning stages or after a train has been booked, for example, where calendar related changes may need to be made. The Calendar contains the dates of a train operation (the start and end date of the running period) and the operational running pattern (e.g. runs Monday to Fridays only).

The calendar is used for the following business purpose:

During the processes of booking a path:

- Path Request – The RU requests a train for a path section; the message will contain the calendar for the whole journey, which is the same for the path section requested, that includes the proposed operational dates/pattern of the train. The date is defined at departure time at reference point. If the reference point is the destination, it refers to the arrival time.
- Answer Not Possible – If, for whatever reason, the IM is not able to process the path request; the message will contain the original calendar requested by the RU along with any errors: logical errors (schedule is not viable) or physical errors (element in the message is unknown /missing)
- Path Details – If the Path Request is processed by the IM who makes an offer back to the RU; the message will contain the calendar(s) with the offered operational dates/pattern for the path(s) section requested. The RU makes one request with one calendar but the IM could reply offering one or more Path Details each containing one calendar that complements the originally requested RU calendar. In addition the locations of the path(s) section offered by the IM, that are in the complete train journey, in Train Information, will also be amended to reflect the calendar offered by the IM
- Path Confirmed / Path Details Refused – The RU either confirms the IM offer or rejects it; the message will contain the calendar of the IM from the Path Details Message

After a path has been booked

- Path Cancelled – The RU is able to make a partial or complete cancellation of the booked path; the message will contain the calendar with the cancelled operational dates/pattern. This has to be a subset or the same as the calendar in PathDetails/PathConfirmed.

- Path Not Available – If it is not possible for the IM to offer a path (e.g. as a result of a disruption); the message will contain the calendar with the operational dates/pattern that have had to be cancelled

### Activating/Deactivating a Path

- Utilisation Notification – For certain networks there is a requirement for the RU to indicate whether a train will run or not against a booked path; the message will contain the calendar with the operational dates/pattern that have either been activated or deactivated. This has to be a subset or the same as the calendar in PathDetails/PathConfirmed.

### Updating the Dossier

- Across all of the processes described above the Dossier Message (either for the locations of the complete journey/path section or for the overall section) will contain a copy of the calendar relevant to the specific process that has taken place. E.g. if the Dossier refers to a Path Request, the Calendar in the Dossier is the same as in the Path Request.

### Receipt Confirmation

- A calendar will be an optional element in this message which relates to the Affected Section. The content of the calendar must be exactly the same as the calendar provided in the message that has to be confirmed.

## 13.14.2 Preconditions for the use of the calendar

The Calendar must be able to work for planning from origin (forward), destination (backward) or an intermediate location (both forward and backward). The location is given at Path Planning Reference Location.

### Path Planning Reference Location Calendar

- For Path Request / Details the “Path Planning Reference Location” element group is used. This is the location at which a Path is planned at to build up the schedule (Path Request) or offered at the production of the path (Path Details).
- It is the Path Planning Reference Location that will contain the only calendar within the Message (at departure time unless the Reference Location is the destination, when arrival is relevant). The Path Planning Reference Location is contained in the Train Information section of the Message.
- No separate calendar should be held for a Path Section. Instead Offsets will be used to derive (calculate) the operational dates that are needed. Offsets are always calculated from the Calendar in the Path Planning Reference Location
- At all of the other locations – for the complete journey (Train Information) and the path section (Path Information) - offsets will be calculated against the calendar in the Path Planning Reference Location.

Offsets are calculated from Arrival or Departure times – How will this work

- According to the given days of service specification contained in the calendar on the Path Planning Reference Location, the offset is calculated on application level for all timing entries (if they are provided – usually, one timing entry is sufficient) from the following list:
  - Earliest Location Arrival (ELA)
  - Actual Location Arrival (ALA)
  - Latest Location Arrival (LLA)
  - Earliest Location Departure (ELD)
  - Actual Location Departure (ALD)
  - Latest Location Departure (LLD)
  
- Case 1, “forward” planning:
  - The first location from the indicated journey (content of the Train Information element) is the reference location.
  - The subsequent locations can have the offset value for timing greater or equal to 0. More precisely, if the time when the train will be at the particular location (any of the timing entries, ELA, ALA etc.) after midnight of the day indicated for the first location of the train journey, the offset value is increased to 1. Consequently, if two midnights should be passed after the train is supposed to depart from the reference location (i.e. the first location of the journey), the offset is increased to 2.
  
- Case 2, “backwards” planning:
  - The last location of the train journey is taken as Path Planning Reference Location.
  - The locations from journey start to the end (which is set as reference point) can have offset values for the timing entries less or equal 0. In the same way as for the Case 1, but only in the another direction, the offset values for times can be changed: if the timing in the last location is ahead over midnight compared to the timing on the one of the previous locations, the offset is set to -1. The same rule applies for other locations previous to this one, if midnight is passed over backwards for the second time on the journey, the offset is set to -2
  
- Case 3, “intermediate” planning:
  - If, in some cases, the handover / interchange point on the train journey is taken as a reference location, the “intermediate planning” is applied
  - The rules for the offset calculation for the stations previous to the intermediate location taken as a reference are the same as the rules for offset calculation for “backwards planning”
  - The rules for the offset calculation for the stations subsequent to the intermediate location taken as a reference are the same as the rules for offset calculation for “forward planning”



### **13.14.3 Calendar used in section related Messages**

- For all of the other messages (PC, PCAN, PDR, ANP, PNA) the calendar is used in conjunction with the affected section that is identified (start location and end location) in the message. The calendar always refers to the start location of that section
- The affected section can be for the whole path section or part of a section.
- Offsets will not be required to be calculated as no specific locations are identified in these messages – only the start and end of a section are provided in the message

### **13.14.4 The Elements of a calendar**

#### **The Calendar Element**

The calendar contains the following elements:

- Start Date = start of the train operation; represented as a DateTime format where the time will not be relevant and will be padded out to 00:00:00 to represent hh:mm:ss
- End Date = end of the train operation; represented as a DateTime format where the time will not be relevant and will be padded out to 00:00:00 to represent hh:mm:ss
- Bitmap Days = Pattern for which the train runs during the start and end date; represented as a bitmap string (1,0)

### **13.14.5 Rules related to the Calendar Element**

- Start Date is a mandatory element and must be present with a date that is within the Timetable
- End Date is an optional element and can either be present or omitted.
- If there is an End Date then
  - It must be later or can be the same as the Start Date (where the train is running for one day)
  - It can be the same as the end of the Timetable period but not beyond
- If there is no End Date then
  - it is assumed that the train will run for just one day
- Bitmap Days is an optional element and denotes the operating pattern of the train
- The Bitmap Days is a string of values where 1 represents a day that the train will run and 0 represents a day that the train will not run; Each value signifies a day between the Start and End Date
- Where a specific pattern is needed (e.g. running every Friday) a Bitmap must be included in the message to reflect that pattern
- If there is a Bitmap days string

## European Railway Agency

ERA/TD/2012-11/INT Annex B.56 of TAP TSI

---

- The size of the string for Bitmap days must equal the number of days between Start Date and End Date inclusive and cannot be more or less. If the pattern is different than this will give rise to an error
- If there is a Start Date and No End Date
  - Then the Bitmap String will not apply as the train will only be running for one day and it is assumed that they train will run that day
  - If the bitmap string is provided, additionally to the start date, it will be applied starting from the start date. In that case, the applications have to check if the bitmap stream crossed over the end of the particular timetable period. For example if there is a start date 15.3. and no End date and a bitmap string “11” this will mean the train will go on 15.3. and 16.3.

### 13.14.6 Using the calendar element

Train running for all days for a period

- Start Date = 1/1/12; End Date = 6/1/12;
- Number of Days the train will run = 6 days
- Without Bitmap Days
  - Start Date = 01/01/2012
  - End Date = 06/01/2012
- With a Bitmap Days
  - Start Date = 01/01/2012
  - End Date = 06/01/2012
  - Bitmap Days = “111111”

Train running for one day

- Start Date = 1/1/12; End Date = 1/1/12;
- Number of Days the train will run = 1 day
- Without Bitmap Days
  - Start Date = 01/01/2012
  - End Date = 01/01/2012
- With a Bitmap Days
  - Start Date = 01/01/2012
  - End Date = 01/01/2012
  - Bitmap Days = “1”
- Without an End Date
  - Start Date = 01/01/2012
  - It is assumed the train will just be running for 1 day of 01/11/2012

Train running for all days for the rest of the Timetable

- Start Date = 12/11/12; End Date = End of Timetable (8/12/12)
- Number of Days the train will run = 27 days
- Without Bitmap Days
  - Start Date = 12/11/2012

# European Railway Agency

ERA/TD/2012-11/INT Annex B.56 of TAP TSI

---

End Date = 08/12/2012

- With a Bitmap Days  
Start Date = 12/11/2012  
End Date = 08/12/2012  
Bitmap Days = "11111111111111111111111111111111"

Train running daily except Sundays for the rest of the Timetable

- Start Date = 12/11/12; End Date = End of Timetable (8/12/12)
- Number of Days the train will run = 24 days
- With a Bitmap Days  
Start Date = 12/11/2012  
End Date = 08/12/2012  
Bitmap Days = "111111011111110111111101111111"

## 13.14.7 Application of the Calendar at the reference location

The application of the Calendar can best be described by the following scenario that shows the interaction of the Calendar

### Situation

A path for a train is requested from location A to E passing through two different path sections. The Handover location is at location C. The train travels for 3 days leaving Location A on Day 1 at 11.30, passing across midnight and reaching Location C at 04.30 on Day 2 and then passing across midnight and reaching Location D at 01.30 on Day 3. The train finally reaches its destination Location E at 18.00 on Day 3.

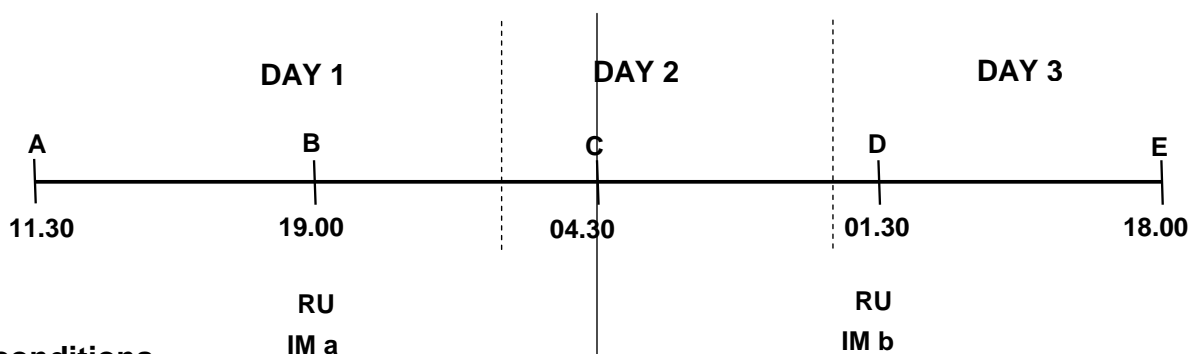

### Preconditions

- This is an Open Access Model with one RU and two IMs (IM a , IM b)
- A daily train has been requested across a start / end date of 30th July 2012 to 3rd August 2012
- The daily train is offered back by the IMs (IM a and IM b) with no changes to the operating pattern
- Location times arrival and departure will be treated as the same (just for this scenario)

# European Railway Agency

ERA/TD/2012-11/INT Annex B.56 of TAP TSI

- The train travels across 3 days leaving Day A at 11.30 and arriving on Day 3 at 18.00 (based on the RU requested timetable)
- No other additional operational locations are added by the IMs
- The Path Request is correct and contains no logical or physical errors
- All train activities and other preconditions have been ignored in this scenario

## Approach

The aim of this approach is to provide efficient RU/IM communication where a train is being requested and offered. In particular this scenario shows how the Path Planning Reference Location, Calendar and offsets will work together.

## RU to IM a

RU -> IM a

### Path Request Message

RU populates Train / Path Information with proposed Locations / Times

Path Planning Reference Location is Origin Location A

Offsets from the Reference Location (A) are calculated in Train / Path Information

Train Information			Path Information		
<b>Path Planning Reference Location</b>					
Location	Calendar Element	Value			
A	Start Date	30/07/2012			
	End Date	03/08/2012			
	Bitmap Days	11111 or Blank			
<b>Planned Journey Locations</b>			<b>Planned Journey Locations</b>		
Location	Time	Offset	Location	Time	Offset
A	11.30	0	A	11.30	0
B	19.00	0	B	19.00	0
C	04.30	+1	C	04.30	+1
D	01.30	+2			
E	18.00	+2			

RU Populated
IM a Populated
IM b Populated
Offset calculated

## RU to IMb

# European Railway Agency

ERA/TD/2012-11/INT Annex B.56 of TAP TSI

RU -> IM b

## Path Request Message

RU populates Train / Path Information with proposed Locations / Times

Path Planning Reference Location is Origin Location A

Offsets from the Reference Location (A) are calculated in Train / Path Information

<i>Train Information</i>			<i>Path Information</i>		
<b>Path Planning Reference Location</b>					
<b>Location</b>	<b>Calendar Element</b>	<b>Value</b>			
A	Start Date	30.07.2012			
	End Date	03.08.2012			
	Bitmap Days	11111 or Blank			
<b>Planned Journey Locations</b>			<b>Planned Journey Locations</b>		
<b>Location</b>	<b>Time</b>	<b>Offset</b>	<b>Location</b>	<b>Time</b>	<b>Offset</b>
A	11,30	0			
B	19,00	0			
C	04,30	+1	C	04,30	+1
D	01,30	+2	D	01,30	+2
E	18,00	+2	E	18,00	+2

RU Populated
IM a Populated
IM b Populated
Offset calculated

## IM a to RU

IM a -> RU

### Path Details Message

IM populates Train / Path Information with offered Locations / Times

Locations / Times and Calendar remain unchanged

Calendar adjusted for Dates from Path Planning Reference Location C

Path Planning Reference Location is changed to Border Location C

Offsets from the Reference Location (C) are calculated in Train / Path Information

<i>Train Information</i>			<i>Path Information</i>		
<b>Path Planning Reference Location</b>					
<b>Location</b>	<b>Calendar Element</b>	<b>Value</b>			
C	Start Date	31.07.2012			
	End Date	04.08.2012			
	Bitmap Days	11111 or Blank			
<b>Planned Journey Locations</b>			<b>Planned Journey Locations</b>		
<b>Location</b>	<b>Time</b>	<b>Offset</b>	<b>Location</b>	<b>Time</b>	<b>Offset</b>
A	11,30	-1	A	11,30	-1
B	19,00	-1	B	19,00	-1
C	04,30	0	C	04,30	0
D	01,30	+1			
E	18,00	+1			

RU Populated
IM a Populated
IM b Populated
Offset calculated

**IMb to RU**

**IM b -> RU**

**Path Details Message**

IM populates Train / Path Information with offered Locations / Times  
 Locations remain unchanged / Times adjusted at Location D & E changed  
 Calendar adjusted for Dates from Path Planning Reference Location C  
 Path Planning Reference Location is changed to Border Location C  
 Offsets from the Reference Location (C) are calculated in Train / Path Information

<i>Train Information</i>			<i>Path Information</i>		
<b>Path Planning Reference Location</b>					
<b>Location</b>	<b>Calendar Element</b>	<b>Value</b>			
C	Start Date	31.07.2012			
	End Date	04.08.2012			
	Bitmap Days	11111 or Blank			
<b>Planned Journey Locations</b>			<b>Planned Journey Locations</b>		
<b>Location</b>	<b>Time</b>	<b>Offset</b>	<b>Location</b>	<b>Time</b>	<b>Offset</b>
A	11,30	-1			
B	19,00	-1			
C	04,30	0	C	04,30	0
D	02,00	+1	D	02,00	+1
E	18,30	+1	E	18,30	+1

RU Populated
IM a Populated
IM b Populated
Offset calculated

**13.14.8 Application of the Calendar in the Affected Section**

This element group will be applied only in case of planning activities related to the full or partial path cancellation, alteration or utilisation notification of a path section.

Affected section is defined first point of section (start point) and the end point of Section (last point). Until the mandatory use of the Train Identification the Affected section contains the Calendar (Start, End and Bitmap) and the OTN. This section can be repeated as needed in order to differentiate sections if OTN is changed across a Path Section, or if an offset has taken a place.

The calendar is transmitted with the Affected section. The calendar that is given for the particular start-end section has to be consistent – i.e. if there is an offset between start and end, regardless of the orientation (forwards or backwards / negative or positive), the particular affected section has to be split into to two affected sections, both containing the corresponding operational pattern and considering the offset in the operational pattern

### 13.15 Handling of Handover in Border Sections

This section provides information on how messages will need to be applied for certain situations crossing network borders<sup>46</sup>.

A border section is a special section between two IM's. The problem is the differences between IM responsibilities. Some border sections can have different definitions of where the responsibility lies. This is the:

- Legal responsibility between IM's for interoperable traffic  
The network border is a point where legal responsibility changes between the IMs (this is the handover point). This can be, but does not have to be in conjunction with a state border.
- Timetable responsibility between IM's for interoperable traffic  
This is the point where there is a change to the timetable responsibility. This can be a mutual border point agreement between the IM's.

In some cases the border section can consist of one or more points which are important for both of the IM's. Those points can have an implication for interoperable or domestic traffic. This can be shown using the following example.

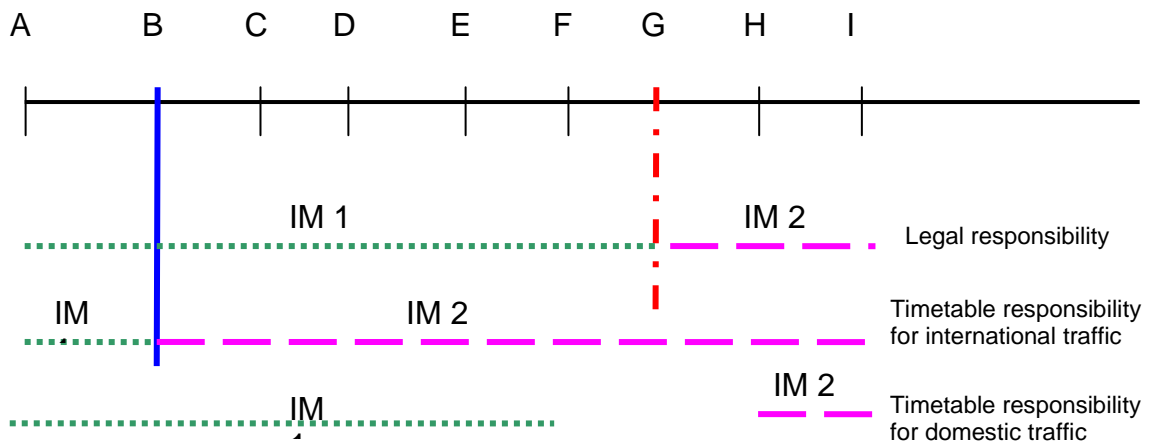

Location B = Timetable responsibility point  
Location G = State border point (only)

The solution for the mutual communication between all stakeholders must be possible for all types of border sections scenarios. IMs will need to identify the mutual agreements of the location points which are important for timetable information for every border section.

<sup>46</sup> The described situation can apply to the border between two IMs within one country as well as to the border between two IMs on a state border

## European Railway Agency

ERA/TD/2012-11/INT Annex B.56 of TAP TSI

---

Those points will be part of Train Information section for Path Details which is created by the IM who is responsible for timetable construction at the border section. In this case the second IM will have all the necessary information that is needed.

The Path Information element will begin and finish between:

- the timetable responsibility points (intermediate)
- between the origin and timetable responsibility point (if origin is in the network section)
- between the timetable responsibility point and destination point. (if destination is in the network section)

The Train Information element will have all mutual agreed points from the border section (especially state border point where is changed legal responsibility between IM's and often between RU's too). This solution solves the problem how to have the necessary information for both IM's and both RU's for every type of border section.



## **Part C - Operation of Trains**

### **14 Train Preparation**

<p>TAP TSI only The section hereunder is relevant for TAP TSI only and has no impact on TAF.</p>	<p align="center">TAF TSI only This section hereunder is relevant for TAF TSI only and has no impact on TAP.</p>
<p>[Not applicable.]</p>	<p><b>13.1. Train Composition</b></p> <p>RU sends the train composition message to all relevant IMs, with which the RU has a path contract for a journey section of the path if IM contractually requires receiving TC message.</p> <p>In open access mode RU has to send TC to all involved IM's, but not necessarily at the same time and possibly not with the same content. In cooperation mode RU has to send TC only to IM with whom it has contract for the path section.</p> <p>On (short) border-sections, where the most of international trains are operated by RUs who do not have contracted path, IM may allow by Network statement or access contract that the RU with a path contract may delegate sending of TC to a partner RU, which runs the train on its behalf.</p> <p>If the collaborating RU partners agree to send TC, the first (previous) RU has to send TC to the next RU only as soon as possible after departure of the train from the last station where it regularly changes its composition, latest before the train arrives to the interchange station.</p> <p>RU should send TC to IM before departure of the train, unless a national rule or contract does not state anything else. TC can be delivered also longer time in advance but from practical reasons the maximum is 72 hours before planned departure if afterwards no change of composition is expected.</p> <p>Whenever there is a change in the composition during the journey of a train, the RU responsible has to update this message to all parties involved.</p> <p><b>13.2. Train Accepted and Train Not Suitable</b></p> <p>After the receipt of the train composition the IM may verify the entries against the contracted path, if the contract between IM and RU explicitly allows this. Depending on the contractual agreement</p>

## European Railway Agency

ERA/TD/2012-11/INT Annex B.56 of TAP TSI

	<p>between the IM and the RU and on regulatory requirements, the IM may also advise the RU if the train composition is acceptable for the booked path. This is effected with the optional Train Accepted message. If the train is not suitable for the previously agreed path, the IM may inform the RU, with the optional Train Not Suitable message. In this case the RU must recheck the train composition.</p> <p>There are 2 options for how IM may or may not respond to the TC message. The IM has to choose one of them and will define conditions in the network access contract:</p> <p>a) IM always verifies TC and responds with messages Train Accepted or Train Not Suitable. RU must wait with sending of Train Ready message for the response from IM. IM has to define time limit for its response. If Train Not suitable message is received by the RU it will respond to the issues raised by the IM. The RU will not complete train preparation without solving these issues.</p> <p>b) IM does not verify the composition and therefore never responds with a message (Train Accepted or Train Not Suitable). RU does not have to wait and can send Train Ready Message when the train is ready.</p>
--	---

### 14.1 Process triggering the Train Ready message

The RU has to achieve train departure tasks as described in OPE TSI § 4.2.3.3, namely:

- the RU must define the checks and tests to ensure that any departure is undertaken safely (e.g. doors, load, brakes);
- the RU shall inform the infrastructure manager when a train is ready for access to the network;
- the RU must inform the infrastructure manager of any anomaly affecting the train or its operation having possible repercussions on the train's running prior to departure and during the journey.

Only second item is concerned by TAF/TAP Train Preparation process. The RU sends the Train Ready message to the concerned IM.

“Access to the network” means that the train, which was until now managed by the RU for the preparation, is now also managed by the IM. It implies that the IM can open the signal to permit to the train to begin its journey.

<p><b>TAP TSI only</b> The section hereunder is relevant for TAP TSI only and has no</p>	<p><b>TAF TSI only</b> This section hereunder is relevant for TAF TSI only and has no impact on TAP.</p>
--	--

# European Railway Agency

ERA/TD/2012-11/INT Annex B.56 of TAP TSI

impact on TAF.	
[Not applicable.]	<p>IM can define the time limit how long before scheduled departure of the train they need to get TR (or vice versa how long time they need to “release green signal” after reception of TR) in the Contract or Network Statement.</p> <p>Each IM should define in the Contract or Network Statement also if they require TR also for trains arriving from other networks. In collaboration mode, TR message for these trains message was sent by “previous RU” to “previous IM”. In open-access mode the TR message was sent from RU to “previous IM”. Because TAF does not assume any data exchange between IMs, it is up to RUs to exchange TR information.</p>

Local rules specify when a “train ready” messages has to be sent.

In practice, a “train ready” message is sent every time a train runs for the first time with its train number. So, the message is sent for example in following cases (unless it is stated that it is not necessary by national rules):

- empty train run from siding to the origin station;
- start of the commercial service with passengers on board from the origin station;
- empty train run from destination station to siding;
- start of the next commercial service performed by the same vehicles that just arrived at the station;
- splitting in two trains (Y traffic) for the train which receives a new number.

That excludes for example (unless imposed by the national rules):

- intermediate stops;
- intermediate planned composition change without change of train number;
- interchange point (between 2 RUs) and hand-over point (between 2 IMs) without changing of train number.

TAP TSI only The section hereunder is relevant for TAP TSI only and has no impact on TAF.	TAF TSI only This section hereunder is relevant for TAF TSI only and has no impact on TAP.
<p>For case where timetable is train ready message, the signal opens at departure time.</p> <p>If the train is not ready (or is expected not to be ready), the RU has also to inform the IM. An option is that the RU uses the same message “Train Ready” with a status “Train Non Ready” and if available, an indication of the expected delay and its reason. This is optional. Also, if the train is expected to be ready at a certain point in time, the message is sent with this forecasted time in “TrainReadyTime”. This is optional as well and has to be mandated</p>	[Not applicable.]

## European Railway Agency

ERA/TD/2012-11/INT Annex B.56 of TAP TSI

<p>by the Network Statement.</p> <p>If information “train not ready” is sent, then an information “train ready” should follow when the train is ready.</p> <p>The message “Train Ready or Not Ready” is sent a “short time” before departure. This “short time” depends on national rules described in network statement or in network access contract.</p> <p>If Train ready information is required at some occasions according to national rules, the same message is used.</p>	
--	--

The “Train ready” message is mandatory.

<b>TAP TSI only</b> The section hereunder is relevant for TAP TSI only and has no impact on TAF.	<b>TAF TSI only</b> This section hereunder is relevant for TAF TSI only and has no impact on TAP.
<p>However if the IM and RU agree not to use the message at given stations and if it is authorised in network statement or track access contract, the RU may inform the IM by using other process or standards than the TAP message, e.g.:</p> <ol style="list-style-type: none"> <li>1. departure on timetable, when the train is ready and departure time is reached;</li> <li>2. other technology or means are GSM-R, digital radio, analogical radio, phone near the signal, mobile phone used by crew, button on the platform, etc.</li> </ol>	<p>TAF defines TR as a structured message, sent from an information system of RU’s to an information system of IM. Anyhow, with aim to implement TAF in a practical and cost effective way, also other options should be possible. This is supported by other EU’s legislation, specifically TSI OPE and ERTMS. Therefore it is proposed to consider the following three options, how RU may deliver TR information to IM:</p> <p>a) TAF TR message will be sent, including the necessary information (mainly Train Identification). It is up to the RU how they collect it and who initiates sending of the message. This way ensures that RU does have the TR data in its own information system.</p> <p>b) GSM-R TR message will be sent, under condition that the train identification is provided in advance or by other means, e.g. when the relation between GSM-R number and the train is established. This has to be mentioned in Network Statement.</p> <p>Moreover, some IM’s consider (in addition to the above options) also a web tool for collection of TR information e.g. via mobile phone or PDA with http or wap capability.</p>

## European Railway Agency

ERA/TD/2012-11/INT Annex B.56 of TAP TSI

	Compliance of such procedure with TAF is not clear, but it may be offered as an additional service to all RU's. Also in this option necessary information (mainly Train Identification) would have to be provided.
--	--

To inform the IM if the train is not ready, different means can be used.

If train is not ready, expected delay and Delay Cause may be transmitted. In practice, Delay Cause is transmitted by a dedicated message when it is known.

The process graph can be seen in Annex 13.

TAP TSI only The section hereunder is relevant for TAP TSI only and has no impact on TAF.	TAF TSI only This section hereunder is relevant for TAF TSI only and has no impact on TAP.
[Not applicable.]	<p><b>13.3 Train at Start / Train Position</b></p> <p>Depending on contractual agreements Train Position and Train At Start Messages can optionally be used:</p> <p>For trains created (originated) outside the public network, e.g. private sidings or lines, ports, terminals, IM may sent to RU the Train Position Message defining exactly when and where the train should present itself to the network as an answer to the train ready message.</p> <p>RU may respond on this message by Train At Start Message to indicate that the train has started its journey.</p>

### 14.2 Content of the message

To inform IM about “train ready”, train number is mandatory.

TAP TSI only The section hereunder is relevant for TAP TSI only and has no impact on TAF.	TAF TSI only This section hereunder is relevant for TAF TSI only and has no impact on TAP.
<p>The status (train ready or train not ready<sup>47</sup>) is mandatory.</p> <p>If train is not ready, expected delay and</p>	<p>The IM may accept the Train Ready Message in advance (in reality, the train is not yet ready, but RU knows when it will be</p>

<sup>47</sup> Waiting approval by Change Control Management

## European Railway Agency

ERA/TD/2012-11/INT Annex B.56 of TAP TSI

<p>Delay Cause may be transmitted. In practice, Delay Cause is transmitted by a dedicated message when it is known.</p>	<p>ready). In this case the RU gives the planned/estimated time of train readiness. This should be part of the contract or network statement.</p>
---	---

If the train starts from a siding yard, optional information is added:

- siding track (to inform the IM which signal must be open);
- destination point (interesting for unplanned trains - trains running without planned path, e.g. short movements between station and siding yard).

All additional information has to be agreed by the correspondent RU/IM.

<b>TAP TSI only</b> The section hereunder is relevant for TAP TSI only and has no impact on TAF.	<b>TAF TSI only</b> This section hereunder is relevant for TAF TSI only and has no impact on TAP.
<p><b>13.5 – Information to the Station Manager</b></p> <p>Stations Managers are informed of Train Ready according to national rules. The same Train Ready message can be used.</p> <p>To inform the Station Manager if the train is not ready, different means can be used. The same message above can optionally be used (with status Not Ready).</p> <p>These messages can be sent in due time under contractual agreement by:</p> <ul style="list-style-type: none"> <li>• IM to SM or</li> <li>• by RU to SM (depending on national railway organisation).</li> </ul>	<p>[Not applicable.]</p>

## **15 Train Running Information and Forecast**

### **15.1 Process triggering the Train Running Information message**

The IM has to provide train reporting at appropriate reporting points indicating actual time and the delta-time value (as described in OPE TSI § 4.2.3.4.2.1). This message is sent to the contracted RU to inform RU controllers. It is not used to inform the driver.

The IM sends to the RU a Train Running Information message as soon as the train reaches contractually agreed reporting points (departure from originating station, intermediate arrival, intermediate departure, run through, arrival at final destination). The reporting points must have a scheduled time<sup>48</sup>.

Reporting at additional points than the agreed ones can be sent by the IM to the RU.

<p><b>TAP TSI only</b> The section hereunder is relevant for TAP TSI only and has no impact on TAF.</p>	<p align="center"><b>TAF TSI only</b> This section hereunder is relevant for TAF TSI only and has no impact on TAP.</p>
<p>[Not applicable.]</p>	<p>Following the TAF TSI requirements, if the train arrives at the Interchange point and the Interchange between the two RUs is completed, the process of Train Preparation for the second RU has to take place. This is similar in the case of handling of the train at the handling point.</p> <p>If the train is handed over between the IMs, for the first IM the process of train running is finished and for the second IM the process of train running is starting at the beginning, therefore with sending the first train running information and all relevant forecasts for its network.</p>

The time limit to send the message after the train has reached the reporting point is defined by national rules or contractual agreement. In practice, the sending is done in “real time” in case of electronic tracking and tracing systems, the time limit has to be agreed in case of manual input in the IT system.

Delay Cause is sent by a specific message (see chapter 19).

The process graph can be seen in Annex 13.

---

<sup>48</sup> In the exceptional case of ad hoc re-routing, the (new) scheduled time might not be known.

**15.2 Process triggering the Train Running Forecast message**

<p align="center">TAP TSI only</p> <p>The section hereunder is relevant for TAP TSI only and has no impact on TAF.</p>	<p align="center">TAF TSI only</p> <p>This section hereunder is relevant for TAF TSI only and has no impact on TAP.</p>
<p>The IM has to provide train forecast at appropriate forecast points (as described in OPE TSI § 4.2.3.4.2.2). This message is sent to the RU to inform RU controllers. It is not used to inform the driver.</p> <p>The IM sends to the RU a Train Running Forecast message as soon as the train reaches contractually agreed reporting points to deliver a forecast time at an agreed forecast point. This implies that the forecast time can be defined. If not, a Train Running Interrupted Message is sent.</p> <p>Forecasts points are agreed by RUs and IMs and are usually stations and hand-over points. Reporting points (triggering Train Running Forecast message) can be origin station, hand-over point from previous IM, interchange point between 2 RUs, points between stations and other agreed points. These reporting points can be different from the reporting points triggering Train Running Information message. The reporting points have usually a scheduled time, the forecast points must have a scheduled time.</p> <p>The message can also be sent before the train starts running</p> <p>It is also sent before train reaches the next reporting point if the forecast delay (increasing or decreasing) varies more than an agreed threshold. This threshold has to be agreed with the actors (current IM, RU and next IM). It could be different from freight trains and also according to passengers trains types (local, regional, long distance).</p> <p>The message is also sent by the IM to the</p>	<p>Sending the train running forecasts</p> <p>After the departure of the train from the origin station, or after taking over the train from the previous IM at the handover point, the IM in charge sends the Train running forecast for the handover point to the next IM and all relevant forecasts (for the handover, all interchange, handling and reporting points relevant for forecast) on its network to RU who has booked the path on which the train is actually running (named “contracted RU”). In addition these forecasts could be sent before the planned departure of the train from the original station or from handover point if such information is available to the IM and IM has a process in place to do it. In the case of ETI (Estimated Time of Interchange), the RU transfers this message to the next RU and additionally to the Lead RU (LRU) for the transport – if there is one and if this is defined in the cooperation contract between RUs. In the case of ETH (Estimated Time of Handover), the IM receiving the forecast for the handover point from the previous IM may take this forecast as a basis for calculating the forecasts for its own network.</p>



## European Railway Agency

ERA/TD/2012-11/INT Annex B.56 of TAP TSI

<p>next IM involved in the train run (forecast point is generally the handover point), details of sending conditions are defined in a bilateral agreement.</p> <p>The forecast time is also sent to the Station Manager in due time i.e. which permits to undertake all stations operations (voice announcements, information display on screens, etc. as agreed between SM and RU and/or IM) before the train arrives in or passes through the station. The message is delivered either from IM to SM, or from IM to RU to SM, under a contractual agreement according to the national railway organisation.</p> <p>The time limit to send the forecast message after the train has reached the reporting point is defined by national rules or contractual agreement (“in due time” according to TAP TSI). With electronic or IT devices in the tracks or in signalling boxes, the calculation and the sending is usually done in “real time”. The “due time” has to be defined in case of manual input in the IT system.</p>	
---	--

The method to calculate the forecast time is defined by each IM.  
The process graph can be seen in Annex 13.

### 15.3 Information to the Station Manager

<b>TAP TSI only</b> The section hereunder is relevant for TAP TSI only and has no impact on TAF.	<b>TAF TSI only</b> This section hereunder is relevant for TAF TSI only and has no impact on TAP.
<p>The Station Manager receives Train Running Forecast messages and Delay Cause messages (see chapter 19).</p> <p>These messages are sent in due time under contractual agreement by:</p> <ul style="list-style-type: none"> <li>• IM to SM or</li> <li>• by IM to RU and then RU to SM (depending on national railway organisation) according to contractual agreement. The</li> </ul>	<p>[Not applicable.]</p>

## European Railway Agency

ERA/TD/2012-11/INT Annex B.56 of TAP TSI

RU may change the value of the message before passing the message on to the SM.	
---	--

### 15.4 Content of the messages

The actual time (element LocationDateTime) is mandatory in Train Running Information.

The forecasted time (element LocationDateTime) is mandatory in Train Running Forecast.

For both messages:

The planned time of a train at the reporting point can be specified in

- BookedLocationDateTime : this is the last agreed (booked) time at this location, also after a re-planning
- ReferencedLocationDateTime: this is the originally (and internationally agreed/published) time.

If no re-planning has taken place, both elements contain the same time.

If the delay (actual/forecasted) is given in the TrainDelay section, the element AgainstBooked has to be used to indicate the delay according to the (last) booked timing. The AgainstReferenced can be used to indicate the delay to the originally planned timing.

The sequence made up from the elements “EnquiryReference” and “Date” are optional and can be used for TAF only.

TAP TSI only The section hereunder is relevant for TAP TSI only and has no impact on TAF.	TAF TSI only This section hereunder is relevant for TAF TSI only and has no impact on TAP.
In addition, other existing standards may be used for the same purpose (i.e. the information provision) if there is a specific agreement between the parties involved to allow the use of these standards.	These messages are also issued as a response to the Enquiry Train Running Forecast /Information Message.

## **16 Service Disruption/Train Running Interrupted**

### **16.1 Process triggering the message**

Events leading to Service Disruption can be caused by external events (e.g. obstacle on tracks), IMs (e.g. CCS breakdown), RUs (e.g. locomotive breakdown).

If the train is stopped due to the disruption and no forecast of its further run is yet available, the Train Running Interrupted messages must be sent from IM to RU.

The meaning of “disruption” is understood nationally. Some events are clearly disruptions, as derailment, catenary galling, tracks under flood, etc. Others are more complex to classify, as locomotive or signal breakdown.

According to the national IM rules, each IM may apply a different threshold beyond which the Train Running Interrupted message must be sent. These thresholds must be agreed in a contract between IM and RU.

Train Running Interrupted messages serve to inform the RU that its train run has been interrupted and a forecast for its further run is not yet possible. The message is the trigger to inform the RU (and the next IM if relevant) and to agree on a solution on how to solve the problem.

The Train Running Interrupted message is sent by the IM to concerned RUs, to the next IM if relevant, and to the Station Managers (either directly or through the RU according to national organisation) for every train that is interrupted.

When RU is responsible and doesn't know how long the repair will take, it has to inform the IM of this service disruption (according to § 4.2.3.3.2 of OPE TSI) by the best way and means (radio, phone, local IT messages, etc.). RU could use the same Train Running Interrupted message (this agreement is out of TAP obligations).

After the problem is analysed, decisions by RU after IM consultation can be (not exhaustive):

1. Delaying the train – the train will wait until disruption has been solved and then will continue as originally planned but with a delay. The accepted value of the delay depends on the negotiation between IM, RU and the next IM and on the situation at the national level. If this solution is taken, the updated Train Running Forecast messages are sent and the process of Train Running continues.
2. Cancellation of train run by RU – due to the disruption, the RU may decide to cancel the train run as it is. In this case, the process of train running for this train has ended and no further train running or train running interruption messages will be sent.

3. Rerouting of train – train will be rerouted, which may lead to the cancellation of the whole or just part of the original path. The relevant processes (path alteration, path cancellation or new path negotiation) might follow.

<p align="center"><b>TAP TSI only</b> The section hereunder is relevant for TAP TSI only and has no impact on TAF.</p>	<p align="center"><b>TAF TSI only</b> This section hereunder is relevant for TAF TSI only and has no impact on TAP.</p>
<p>If the time for the path alteration/cancellation/new negotiation is missing, the train journey modification can be applied. See chapter 18.</p> <p>The process graph can be seen in Annex 13.</p> <p><b>16.2 Information to the Station Manager</b></p> <p>Station Manager could be informed using national procedures.</p> <p>Train Running Interrupted message (chapter 15) and Delay Cause message (chapter 19) can also be used according to agreement.</p> <p>These messages are sent in due time under contractual agreement by:</p> <ul style="list-style-type: none"> <li>• either IM to SM</li> <li>• or IM to RU and then RU to SM (depending on national railway organisation) according to contractual agreement. The RU may change the value of the message before passing the message on to the SM.</li> </ul> <p><b>16.3 Information storage</b></p> <p>To fulfil passenger’s rights regulation, TAP TSI requests to store service disruption data during 12 months.</p> <p>As service disruption means only that the forecast cannot be sent immediately, the utility is limited as the train running information and forecast can nevertheless be sent later.</p> <p>To fulfil the passenger’s rights regulation, the requirement for data to be stored should therefore be understood for Train Tuning Information instead.</p>	<p>[Not applicable.]</p>

**16.4 Content of the message**

The Location where the interruption occurs has to be given. If the train is stopped at a location not existing in the reference file, the next location from the reference file has to be given.

For the exact specification of the location the option element Detailed Description Of Location can be used (free text).

In addition the cause of interruption and the estimated duration (earliest and/or latest estimated end time) can optionally be stated. At the very moment of sending the message the possible cause don't have to be yet identified. However, whenever possible the delay cause coding should be used.

The Internal Reference Identifier can optionally be used to specify the IMs internal system reference (e.g. incident number). The Internal Reference Number refers to a propriety identification used by an IM to reference a specific event. For example, the IM might give an incident number to a signal failure and refers to that signal failure for delay communication. The Internal Reference Number is not specified on European level.

The Train Running Interrupted message will be treated only as a message to inform about the interruption of a single train run.

TAP TSI only The section hereunder is relevant for TAP TSI only and has no impact on TAF.	TAF TSI only This section hereunder is relevant for TAF TSI only and has no impact on TAP.
In addition, other existing standards may be used for the same purpose (i.e. the information provision) if there is a specific agreement between the parties involved to allow the use of these standards.	However, it is possible for a single IM to adapt the message to be used also for multiple trains. But this is left to a decision of a single IM and is not being harmonised or regulated at the TAF TSI level.

## 17 Change of Track/Platform

### TAP TSI only

The section hereunder is relevant for TAP TSI only and has no impact on TAF.

### TAF TSI only

This section hereunder is relevant for TAF TSI only and has no impact on TAP.

This message<sup>49</sup> is needed to enable the Station Manager to fulfil passenger information requirements according to TAP BP 4.2.12. The SM shall inform the passenger about changes of track for train services. The information needs to be delivered to the SM.

[Not applicable.]

### 17.1 Process triggering the message

In case a train service shall not arrive or depart on the originally planned track/platform, the IM has to inform the RU and the SM (directly or via the RU) in due time before the arrival of a train (or before the departure at origin) for passengers information in station.

Beside local agreement, the following message can also be optionally used.

This message concerns the relevant information for passengers in stations, where to board a train. According to local circumstances, this is a track in platform (track adjacent to a platform) or a platform itself<sup>50</sup>. It does not cover the information on any other tracks on route of the running train.

If the platform number is different to the track number the unique reference (track number) shall be used.

The message is sent in due time under contractual agreement by:

- either IM to SM and RU;
- or IM to RU and then RU to SM (depending on national railway organisation).

The process graph can be seen in Annex 13.

### 17.2 Content of the message

The message shall indicate the new track/platform, where the

<sup>49</sup> Waiting approval by Change Control Management

<sup>50</sup> The meaning of track can be understood differently. In this context, track means the location where a passenger can board a train.

**train service is foreseen to stop.**

**Difference between technical track and public track should be noted: The unique reference of the platform edge is mandatory. National rules have to identify unambiguous if the public name or the technical name of a track in platform is used.**

**In case local or national agreements require only the IM to inform the SM always, proprietary messages can be used as this is a fixed relationship.**

## 18 Train Journey Modified

### TAP TSI only

The section hereunder is relevant for TAP TSI only and has no impact on TAF.

### TAF TSI only

This section hereunder is relevant for TAF TSI only and has no impact on TAP.

This message<sup>51</sup> is needed to enable the Station Manager and the Railway Undertaking to fulfil passenger information requirements according to TAP BP 4.2.12 and 4.2.13. The SM and the RU shall inform the passenger about deviations from plan. The information needs to be delivered to the SM and/or RU. The same message can be used to inform the next IM if relevant: whole train cancellation, rerouting, retiming at hand-over point, etc.

[Not applicable.]

### 18.1 Requirements on messaging

According to BP 4.2.12 RUs and/or IMs have to provide real time information on the train run to the SM. For Material delays, the Train Running Forecast Message and the Delay Cause Message are appropriate.

For full or partial cancellation and Train re-routing, messages from Short Term Path Request cover similar content. However, the process of creating a new path is outside the operational control and would be inappropriate for real-time information. Therefore, a Train Journey Modified message can be used.

### 18.2 Process triggering Journey Modified message

In case a train service cannot use its planned path and serve its planned stopping pattern, RU and IM have to decide on the continuation of the train (this could start after the IM has issued a Train Running Interrupted message). The following possibilities can occur:

- The whole train service is cancelled completely
- The train service is partly cancelled (could be at the beginning, the end or between intermediate points of the train journey).
- One or more single stops are cancelled.
- One or more single stops are added.
- The train is rerouted. Rerouting can be understood as a combination of stop cancellation and stops added.

<sup>51</sup> Waiting approval by Change Control Management



If these solutions are envisaged for future train runs, these shall be handled within the Short Term Path Request. For operations (non-future, the train is running or, according to national rules, prepared and/or foreseen to run) the Short Term Path Request processes may be too slow to provide the information in real time.

Specific messages, are foreseen and can be optionally used according to contractual agreement. These messages have only informational character and do not substitute the formal process of train journey modification. These messages do not automatically change the path contract.

The operational messages on journey modified are sent once IM and RU have agreed (manually or using standards outside TAP TSI) on the continuation of the train. They can be sent from

- RU to SM
- IM to SM
- IM to RU (and either RU to SM)

The information in these messages is used for customer information.

### **18.3 Change of Train Number (OTN)**

In case the modification of the train journey requires a change of the train number (OTN), the IM has to inform the RU about the new OTN. This can be done using manual processes and manual input into the individual systems of IM, RU and SM would then be needed.

Process may change when TRID is implemented.

### **18.4 Content of the Message**

IM or RU informs the SM and/or the contracted RU on the modified journey.

The journey modified message serves the different scenarios.

- **Whole Train Cancellation:**  
The indication “Whole train cancellation” is given. The first and the last location of the (foreseen and now cancelled) train service is given.
- **Partial Train Cancellation:**  
The indication “Partial train cancellation” is given. The first and the last planned location that are no longer

served by this train service are given. All stations in between, including the given first and last planned location, are not served by this train any more.

In case this partial train cancellation is given between intermediate stations, it is understood that there is no through train anymore.

- **Station Stop Cancellation:**  
The indication “Station Stop Cancellation” is given. Only the given location (1 to many) is cancelled. The train continues to serve all other planned stations.
- **Additional Station Stop:**  
The indication “Additional Station Stop” is given. All the given locations (1 to many) are added to the original train. All other planned stops are served as planned.
- **Rerouting:**  
The indication “Rerouting” is given. Every single station stop that is no more served has to be given with the “station stop cancellation” status. Every single new station stop that is added due to rerouting has to be given with the “additional station stop” status.  
Rerouting is in fact a mixture of “Station Stop Cancellation” and “Additional Station Stop”.
- **Retiming**  
A station stop can receive a new timing, following the train modification. The elements Scheduled Time at Location and Train Location Status have to be filled then.

One message can include a mixture of these scenarios. Therefore, the Train Journey Modification is 1 to many.

In case local or national agreements require only the IM to inform the SM always, proprietary messages can be used as this is a fixed relationship.

## 19 Delay Cause

This chapter applies when IM has to inform the RU (and if relevant next IM) of the reason of a delay, this delay could appear during normal running, service disruption, rerouting, journey modification, etc (see in particular chapters 15 and 16).

### 19.1 IM informs the RU on the delay cause

The IM has the responsibility to find the cause of a delay, according to national rules, and to enter the Delay Cause into the IT system.

The dedicated Delay Cause message is issued by the IM to the contracted RU as reasonably possible to make known the cause of an additional delay in a train's journey.

The acknowledgement of the Delay Cause is made by internal process. Dispute process is described by national rules.

Unless otherwise agreed, the Delay Cause message has not to be sent to the next IM (the forecast message at hand-over point is sufficient).

Under agreement, the Delay Cause can be sent from a RU to the partner RU(s).

TAP TSI only The section hereunder is relevant for TAP TSI only and has no impact on TAF.	TAF TSI only This section hereunder is relevant for TAF TSI only and has no impact on TAP.
If the RU wants to inform the passengers in stations of the reason of a delay, the Delay Cause message can be used. The message is delivered to the Station Manager under a contractual agreement by the IM or the RU according to the national railway organisation. It is delivered in due time i.e. which permits to undertake the announcements (voice, screen, etc.) before the train arrives in the station.	[Not applicable.]

Main rules concerning Delay Cause message are:

- every delay (incl. every additional delay<sup>52</sup>) should be reported, not only those happening at reporting points;
- if a delay occurs at points not included in reference file, it will be shifted to the next reference file point;

<sup>52</sup> Additional delay – occurs, when the new delay event appears. It is the first delay and every increase of the delay during the train run. Examples:

- a) train was on time in previous point and now is delayed for 5 minutes: additional delay is 5 minutes;
- b) train had 5 minutes delay and now is delayed for 7 minutes: additional delay is 2 minutes;
- c) train was 10 minutes in advance and now is only 5 minutes in advance: no additional delay;
- d) train was 5 minutes in advance and now is 3 minutes delayed: additional delay is 3 minutes.

## European Railway Agency

### ERA/TD/2012-11/INT Annex B.56 of TAP TSI

- Delay Cause message should be sent at the moment when the code for a delay is specified (according to UIC leaflet 450-2)<sup>53</sup> and always when the code is changed;
  - one message is sent for each Delay Cause.
- in case the reason of the delay is changed (but the delay duration stays the same), the updated message with the new Delay Cause code and status alteration will be sent,
- in case the original delay time is changed (e.g. split of delay into more causes) the deletion of the original messages must be sent and new messages with the new codes must be sent;

It is out of the scope of the TAF and TAP TSI to define the detailed rules for coding or validating the delay causes, or to specify any threshold values for coding of delays. The threshold for coding the additional delay is depending on the national law or internal IM rules. The only requirement is that whenever the code for the delay is defined or changed, the Delay Cause message should be sent to the contracted RU.

<b>TAP TSI only</b> The section hereunder is relevant for TAP TSI only and has no impact on TAF.	<b>TAF TSI only</b> This section hereunder is relevant for TAF TSI only and has no impact on TAP.
---	--

<sup>53</sup> Excluding unspecified default codes (like „00“)

<p><b>19.2 RU informs the IM on the Delay Cause</b></p> <p>In case the RU wants to inform the IM, it can use the same Delay Cause message from RU to IM according to agreement.</p> <p>(This agreement is outside the obligations described in TAP TSI).</p> <p><b>19.3 RU informs the IM about restrictions</b></p> <p>According to OPE TSI § 4.2.3.3, the RU has to inform the IM about restriction (i.e. any anomaly affecting the train or its operation having possible repercussions on the train's running) prior to departure and during the journey. This information is made according to agreed rules and is out of TAP obligations.</p> <p><b>19.4 Information to the Station Manager</b></p> <p>Delay Cause message is sent in due time under contractual agreement by:</p> <ul style="list-style-type: none"> <li>• IM to SM or</li> <li>• by IM to RU and then RU to SM (depending on national railway organisation). The RU may change the value of the message before passing the message on to the SM.</li> </ul>	<p>[Not applicable.]</p>
---	--------------------------

The process graph can be seen in Annex 13.

**19.5 Content of the message**

The DelayLocation where the delay occurs has to be given. If the train is stopped at a location not existing in the reference file, the next location from the reference file has to be given.

In addition the time, when the delay occurred (DelayEventDateTime), the amount of the delay (DelayTime) and the cause of delay (DelayCause) have to be stated. The delay cause coding has to be used.

The Internal Reference Identifier can optionally be used to specify the IMs internal system reference (e.g incident number). DelayCodingDateTime can optionally be used as a time stamp when the coding was done. This can serve to create a history of coding.

---

## 20 Passengers information in station area and vehicle area

### TAP TSI only

The section hereunder is relevant for TAP TSI only and has no impact on TAF.

### TAF TSI only

This section hereunder is relevant for TAF TSI only and has no impact on TAP.

---

Information has to be provided by displays or voice announcements in stations at which trains performing international service stop and within the vehicle area of trains performing international service. That concerns planned information and also real-time information in case of deviation of the plan. This chapter shows which chapters need to be consulted to get the real time information.

[Not applicable.]

### 20.1 Passengers information in station area

The Station Manager has the responsibility to inform the passengers with train running information within the station via voice announcements and/or display.

This applies at least in respect of stations at which trains performing international services stop.

Information described in TAP TSI § 4.2 is provided to Station Managers by IM and/or RU according to contractual agreement.

Real time information is provided according to messages described in sections 12 to 18. Other information is provided under contractual agreement (means, rules, process, etc.)

### 20.2 Passengers information in vehicle area

The RU has the responsibility to inform the passengers with train running information within the vehicle area via voice announcements and/or display systems. This applies at least to all trains performing international services.

Information described in TAP TSI § 4.2 is under RU responsibility or is provided by IM to RU according to contractual agreement.

Real time information is provided by IM to RU according to messages described in sections 12 to 18. Other information is provided under contractual agreement (means, rules, process, etc.)

## 21 Train Location

<p align="center"><b>TAP TSI only</b> The section hereunder is relevant for TAP TSI only and has no impact on TAF.</p>	<p align="center"><b>TAF TSI only</b> This section hereunder is relevant for TAF TSI only and has no impact on TAP.</p>
<p>[Not applicable.]</p>	<p>These messages enable the RU to ask whenever needed the IM about the current situation of its train according to bilateral agreement between the RU and the IM.</p> <p><b>21.1 Train Location Process description</b></p> <p>As all information included within enquiry messages have to be sent prior mandatorily, the enquiry messages are optional. IM may decide if he will provide them as service or not. The usage of enquiry message must be agreed between the contact partners or to be stated in Network Statements.</p> <p>The train enquiry messages may be sent by the RU to the IM with whom it has contracted a path. After receiving the enquiry, the IM will send the appropriate response message. Only the contracted RU could enquire about the train – the basis is the path contract (company ID from path details).</p> <p>If the RU sends an invalid enquiry, the IM is not obliged to send an answer, but may send the message Answer not Possible or Inadmissible.</p> <p>According to the TAF TSI, the response time for enquiries must be less than 5 minutes (from time of receiving to time of sending).</p> <p><b>21.2 Train Location Messages</b></p> <p><b>21.2.1 Enquiry about Train Running Information</b></p> <p>This message serves to enquire about the running status of a specified train. The RU is only allowed to enquire about its own trains (RU that has booked the path on which the train is actually running).</p> <p>The RU may specify for which location the Train Running Information is requested. If this is not specified in the enquiry, the last reporting location with last reported status should be sent as response.</p> <p>The requested status may also be specified (departure, arrival, and run-through). If the requested status is not available or if</p>

---

status is not specified in the enquiry, then the last known status should be sent as a response.

Train Running Information message should be send as an answer to this message.

#### **21.2.2 Enquiry about Train Running Forecast**

This message serves to enquire about the forecast time for a specified train at a particular reporting location. The RU is only allowed to enquire about its own trains (RU that has booked the path on which the train is actually running).

The RU may also specify which status is requested (departure, arrival, and run-through). If the requested status is not available, the IM sends the forecast for arrival, arrival at final destination or run through.

Train Running Forecast message should be send as an answer to this message.

#### **21.2.3 Enquiry about Train Delay Performance**

This message serves to enquire about all of the actual delta t values in the Handover, Interchange, Handling and all Reporting points concerning a specified train within network of particular IM and the causes of all additional delays.

The RU may request this message within at least 3 days after midnight of the day when the last movement of the train on the IM network happened. Every IM should be able to provide the answer within this time frame. A request sent later may be impossible to answer due to different local arrangements involving the IMs.

#### **21.2.4 Train Delay Performance**

This message is issued following receipt of an enquiry about the train delay performance. It delivers a report of all the actual delta t values concerning a specified train at all reporting points within network of particular IM and causes of all additional delays.

There are two main parts in the message:

1. Train Location report – consists of the list of all the actual delta t values in all reporting stations (Handover, Interchange, Handling and Reporting points).



**2. Delay event report – consists of the list of all the delay events (additional delays). If no delay is recorded this report does not have to be made. In this report every additional delay should be reported – not only those happening at the reporting location but also those occurring at points not included in the reference files. Additional delays occurring at points not included in reference files will be shifted to the next reference file point. All the delay causes should be reported. If the national system codes the additional delay automatically at the moment it happens with the default code, e.g. 00, or if the code 00 is used to specify that the cause is not known, these cases should not be reported. Only the codes consistent with the coding in the new UIC Leaflet 450-2 should be reported.**

#### **21.2.5 Enquiry about Train Forecast At Reporting Location**

**This message is used to enquire about the forecasts for all the trains of a RU to/from a certain reporting location.**

**The specification of the reporting location is mandatory and in one message only one location may be enquired about.**

**The RU may also specify the following items in the message:**

- **Train location status – to specify the status that the forecast is being enquired about. If the requested status is not available, the IM must send the forecast for arrival, arrival at final destination or run through.**
- **Requested time frame – this enables the RU to specify the time period for which the forecasts are requested. The requested time frame is relevant only for the forecast times, not for the scheduled times. So if the train was scheduled within the time frame but is delayed and the forecast is out of the time frame, the train will not be reported. Thus the RU will get forecast information about all the trains heading for a given location during a given time frame (it is not important if the train was scheduled to arrive there within this time frame or not). All trains for which the current forecast is within the time frame will be reported. If no time frame is specified in the enquiry, all the trains for which forecasts are available will be reported.**

**Requested Time frame may be further specified by:**

- 1. Beginning of time frame: if not specified, the start is right now i.e. the time when the answer starts to be formulated**
- 2. End of time frame: IMs may limit the maximum requested time because the quality of the provided forecast**

---

depends on the time frame and the location enquired about...  
A larger time frame could lead to a lower forecast quality.

#### **21.2.6 Train Forecast at Reporting Location**

This message is issued following receipt of an enquiry about train forecasts at a particular reporting location.

This message should consist of all the forecasts for all the trains moving towards a specified location within the requested time frame, if specified in the enquiry.

In the answer message, only the trains for which the forecast at the time of requesting is available and that have not yet passed this point will be reported. If train running information is already available for the point, the forecast is not relevant anymore and therefore should not be reported. The forecast for trains which have already started to run but are not yet present on the network of the relevant IM may also be reported depending on whether the IM is calculating the forecasts for their network based on the ETH received from the neighbouring IM.

To avoid the situation where one IM will have to include forecasts for hundreds of trains in its response, the choice regarding how many trains may be included in the answer to this message should be left open for each single IM. The number of trains should be based on the agreement between IM and RU. It may be defined via the thresholds values in Requested time frame or it may be done by stating the maximum number of trains to be included in one report. The way of limiting the number is left to a decision at the national level.

#### **21.2.7 Answer not possible or inadmissible**

This message may be used by the IM in case the Enquiry message cannot be answered. For example, if the RU is enquiring about a train which is not known to the IM, or which has not yet entered the network of an IM, the IM cannot send any of the messages that exist so far.

## Part D - Overall requirements

### 22 General remarks

This chapter provides information on general requirements, further explanations and information to be taken into account when implementing the RU/IM Message exchange.

#### 22.1 Use of Train Number and Train Identifiers

Depending on the individual implementation OTN or Train Identifiers and OTN are used.

TrainIDs etc. are used mainly within IT systems to make the unambiguous link between the elements path, train, dossier, path request etc.

The Train Identifier will however not be used in normal human communication. The OTN continues to be used in human communication (signaller – driver etc.) and remains also for signalling systems.

The possibility to use Service Number<sup>54</sup> for communication with passengers (station boards, screens, on tickets) is not affected by the introduction of Train Identifiers.

#### 22.2 Explication of difference between train and path

The split between IM and RU, has changed the way each company sees the train. An IM is no longer running a train, but instead providing a path to run a train on. A RU is running a train which could run across many IMs. The planning of both path (IM) and train (RU) can now follow a different life cycle. An IM may need to serve many RUs and must design paths to meet all RU's needs. While a RU may have choice of many aspects of the train such as the route. For this reason the workgroup concluded that the path and train must have a possibility to be separately identified and the train number must be kept for compatibility with legacy signalling and systems. Therefore, there has to be a possibility in the messages provided which allows the separate identification of train and path related issues, and which considers different lifecycles such as planning of a train and operation of a train. The original TrainIdent that was specified during the CEN development phase was not appropriate due to the complexity of the handling the operational train numbers in relation to the unique identifier within each of the application systems. The new coding structure allows better compliance and matching to commonly used identifiers resident in the diverse applications. According to the complexity of the business scenarios discussed in the Implementation Guidelines, the following object types are recognized:

- Train
- Path
- Path Request

---

<sup>54</sup> Service Number is used in the Retail part of TAP TSI, see TD B.4

- Case Reference (used for identification in the planning cycle, carries the identification information of the planning dossier, and used for short term re-planning of a train in the operational phase)

These object types of the identifiers can be used in planning and in the operational phase. Therefore, the two composite identifier types are modelled: one for the usage in the planning phase and one for the usage in the operational phase. The composite identifiers reflect the following structure:

- Object type indication (train, path, path request or case reference),
- Identification of a company that created the identifier,
- Core of the identifier
- Variant of the identifier which serves to establish the relation between two identifiers used in the same business case
- Timetable year (indication of the validity period of the identifier)
- Start date of the particular train (the indication of the start date for the train is mandatory in the operational phase, but it is not mandatory in the planning phase)

### 22.3 Use of common elements in the messages

#### Free text field

Normally local language is to be used but in bilateral agreements a different rule could be agreed upon.

#### Message reference

In case of alteration or deletion of the message the reference to the original message should be made via the functional data as a key (e.g. Train Ident, Location Ident).

### 22.4 Mandatory or Optional Elements in the Messages

Within the message structure, there are number of elements that are either mandatory or optional.

- Mandatory elements have to be in the message content for all message exchange.
- Optional fields only need to be filled in where there is a need to have them between RU/IM or where network regulations may well dictate or where there is mutual agreement to do so.

Optional status may well apply to individual elements or groups of elements (e.g. the use of ON DEMAND path element may only be relevant to the RU and IMs in certain networks where it is possible to have prearranged paths).

Optional elements may also apply to groups of elements where the entire group may be either needed or not needed.

Where a message element is identified as 'optional', this may be changed by the IM who may declare it as mandatory according to the requirements in their Network Statement for their path section. It will be mandatory for interoperable/international trains where there is a requirement to use an element as per their national regulation. This will mean that all validation rules of the element(s) will be applied as per normal.

In addition, some elements and sub-elements are conditional. That means, they are optional in a technical sense, but if there is a specific business need or purpose – based on IMs requirement (published in the Network Statement) – some or all of the (sub-) element will be mandatory.

There are also a number of elements that are either mandatory or optional depending on whether they are for freight or passenger traffic.

Several message elements are global, that means they are used for communication purposes in several processes (e.g. for planning and operations). E.g. some message elements used in the 'Short-term path request' have to be optional from the technical point of view because they are optionally in operations, but must be mandatory when they are applied for planning and vice-versa.

### 22.5 Message exchange partners

Messages are exchanged between parties having a business relation with each other. That means that a message exchange is between the

- IM and the RU that wants to or already has booked a path with this IM
- IM and the neighbouring IM involved in the train panning or operation
- IM and/or RU and the SM involved in the operation of the train
- RU and any partner RU involved in the train planning or operation (this possibility is on bilateral agreement outside TAF and TAP obligations).

For example, for a train running on two IMs and operated by two RUs (one per IM) the information flow can be

- IM 1 to IM 2 and then IM 2 to RU 2; or
- IM 1 to RU 1 and RU1 to RU 2

depending on the agreement.

### 22.6 Masterplan for central functions

In order to efficiently start the RU/IM Message exchange, the following preconditions need to be fulfilled:

- Reference file system (database as described in chapter 10) is technically available. Governance for Reference file is to be defined in 2012.
- Each member state designates the national entity.
- Reference file shall be initially filled by national entity in 2013 (each IM has to decide which clean data goes inside).

## 23 Data quality

In order to efficiently use the RU/IM message exchange and the related applications good data quality is essential. Data quality requirements are shown in the following picture:

### Generic data quality requirements

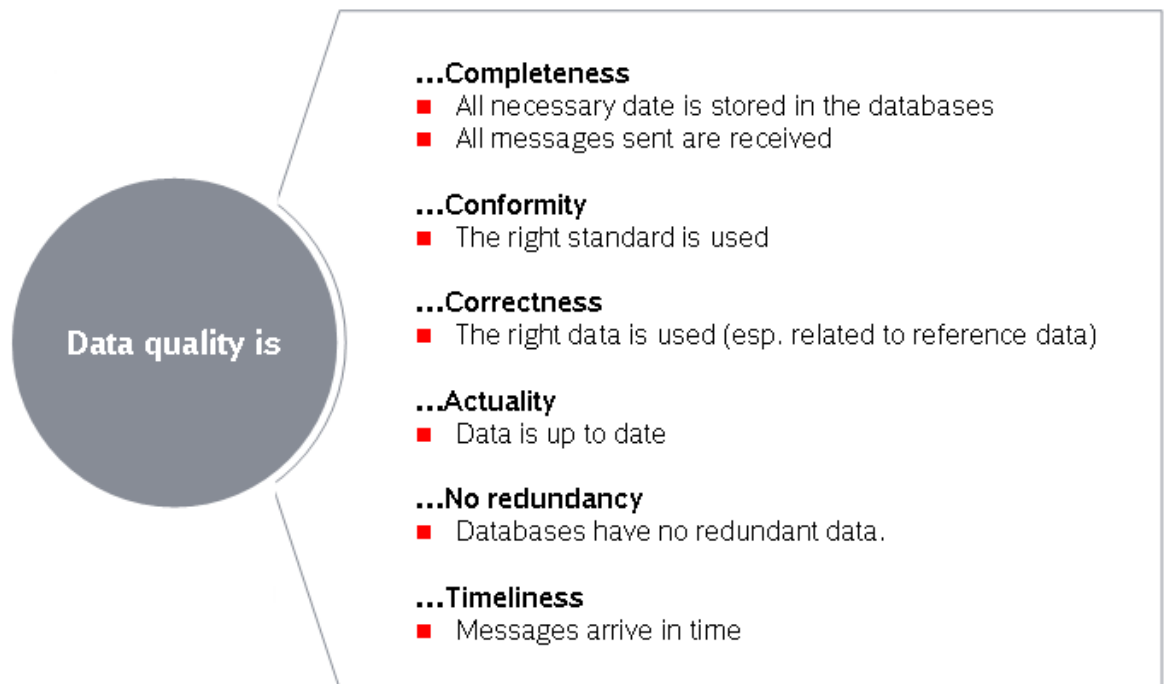

The following general rules to reach a high data quality in the RU/IM message exchange apply:

- Data quality is the responsibility of the sender.
  - Before having been sent messages must be checked by the sender in order to ensure that its is well-formed, complete and valid (against the message/elements as defined in the message catalogue).
- Data quality (can and) will be measured by the receiver of the message.
- The receiver talks to sender in case the data quality needs to be increased.
- Messages sent shall be secured by signing, encrypting<sup>55</sup> and compressing the message:
  - All IMs and RUs involved in the communication shall have the certificate from the Certification Authority to use encryption and signing certificate.
  - Encryption (using SSL/TLS) shall be provided assuring privacy and authentication of the sender and avoid man in the middle attacks.
  - Signing shall be used to assure integrity of messages.
  - Two actors keeping a communication should have the certificate generated with same Root certificate to work with encryption functionality and a security alias of the certificate should be provided.

<sup>55</sup> It is up to the involved parties to decide whether every message (type) needs to be signed and encrypted beside the secure transport.

The following possibilities are supported by the RU/IM architecture to detect and increase data quality:

- Syntactically incorrect messages are placed in temporary storage for analysis and reporting (Dead letter queues - storage of message that could not be delivered in a Common Interface or on application level). This would indicate problems in format data quality.
- [In case a message is not delivered (no acknowledgment by the CI) the message can still be found in sending queues. – It is up to the sender to check the delivery.]
- The Answer Not Possible message (ANP) in the Path Request process can be used to report and measure semantic data quality (content level). The ANP message is sent from the receiver of an earlier message to the sender of that earlier message. The message is used when the information in the original message was not good enough to create an answer. The message supports a list of elements that have errors or could also be business related errors (e.g. a schedule is not logical). The level of detail of this ANP message will depend on the application that emits this message. It should be as detailed as feasible with the legacy system with the minimum information: Message was not usable. Detailed information, if supported by legacy system, shall use a subset or all of the common error codes described for ANP.
- In case of the same message with the same content (e.g. train running message for train X at location Y sent several times), rules like “Last message wins” would avoid the handling of ambiguous message information. This has to be implemented at application level.
- For the central reference database, specific Entities are responsible for the storage of specific codes (e.g. national entity for primary codes in its country). This Entity has to make sure, that one location is coded once – avoiding ambiguous codes like 10 different primary codes for the same physical station (for example only). See also chapter 10.6 for quality requirements on reference data.
- Timeliness of message exchange can be checked on application level, e.g. comparing the actual timing of a train run and the timestamp of the message arriving. It depends on contractual agreements.

## **24 Functional Governance**

This chapter provides information about contact and processes for receiving the certification for the RU/IM message exchange and for functional changes. This includes ways to request code values and also ways to request changes in the message structure.

### **24.1 Code allocation**

Codes are divided into three categories:

- **A** for functional codes that have no impact on the message exchange. It represents functional information that is sent through the messages for functional use within the business processes (e.g. planning of a short term train)
- **B** for process codes that have a relevance for the way applications deal with the message (e.g. the status of the message new, update, delete)
- **C** for external codes that are used within the business processes but are controlled by different domains (e.g. Retail, UN Codes) that have their own governance processes. A reference to the controlling body is given.

#### **Processes for the maintenance of codes**

- Category A:
- These codes are maintained within the domain of RUs, IMs and SMs. Any involved stakeholder (e.g. RU, IM, AB) can put the request for a change (new, alteration, deletion) to the technical services management group in the governance entity. The entity can consult relevant expert working groups on the need of that change within 2 months. The entity attributes a code value and informs the Supervisory Board. The entity publishes the code soon after.
- Category B:
- These codes are maintained within the domain. Any involved stakeholder (RU, IM, AB) can put the request for a change (new, alteration, deletion) to the technical services management group which has to consult relevant expert working groups on the need of that change within 2 months notice. The working group can reject, ask for clarifications and give a recommendation, eventually following an impact analysis. If approved, a migration strategy has to be developed as well. On recommendation of the working groups the service management group attributes a code value and recommends approval from the Supervisory Board. The entity publishes the code and the migration plan soon after that confirmation. The code can be used according to that migration plan or bilateral agreements.
- Category C -> see respective controlling body. The entity publishes these codes as well for information as soon as they are known. A delay notice until the use of these codes can be agreed.

The ERA TAF and/or TAP CCM WP will be informed on the changes of the codes.



---

## **24.2 Change of messages and/or the structure of the reference file:**

The messages are maintained within the domain. Any involved stakeholder (RU, IM, AB, SM) can put the request for a change (new, alteration, deletion of a message) to the technical services management group. It has to consult the relevant expert working groups on the need of that change with 2 months notice. The working group can reject, ask for clarifications and give recommendations, eventually following an impact analysis within a given timeframe. If approved, a migration strategy has to be developed as well. On recommendation of the working groups the entity asks the Supervisory Board for confirmation. The entity publishes the changed messages and the migration plan soon after that confirmation and puts it into the ERA CCM according to chapter 7 of both TAP and TAF TSI. The message can be used according to that migration plan or on bilateral agreement.

For:

- optional change to existing specifications – information to Supervisory Board is sufficient
- mandatory change to existing specifications and new specifications:  
Any stakeholder gives a request with justification for the change to the entity. The entity, together with the relevant SMG, creates a workplan. This plan is also used to inform the stakeholders in order to allow experts to be sent to working groups. Work is done by the WG following the approval of the workplan by the Supervisory Board. The result of the WG needs to be approved by the SB as well and is published subsequently.

Change of message can only be once per year on a given date. Migration plan needs to allow companies to implement it (communication of change at least 1 year before usage).

A migration plan should be proposed by the WG, including a minimum period in which the change is optional and a time from which the change is mandatory.

The WG of the TAF and TAP governance entity should take into account both business and IT needs.

## **24.3 Allocation of certificates for messages**

Every participant in the RU/IM message exchange will have to use valid (X509) certificates for secure communication and if needed for message encryption and signature. These certificates are issued under the authority of the governance entity.

Every company has to register once to central admin (currently this is the admin of CCG); The governance admin service will verify the user and will subsequently grant access to a secured website where certificate can be downloaded.

The Expiry dates of the certificate are mentioned in the certificate. The company has to make sure to get a new certificate before.

#### **24.4 Access to reference data**

Every stakeholder in the RU/IM message exchange needs to register for the message exchange (see 23.3 on allocation of certificates) through the governance admin service. Following certification, the stakeholder has access to all location codes stored in the Central Repository Domain. The reference data can be used for all TAP and TAF purposes and related processes. To perform these processes, stakeholders may give the data to suppliers under the precondition that the stakeholder ensures the data is solely used for these purposes and is not used for other commercial activities.

Access to all reference data will be provided through the use of a reference data service managed by the governance entity. This service will meet the requirements described in this Implementation Guide or as subsequently decided by the governance entity. Access requirements are not subject to approval by the TAP-CCM or TAF-CCM.

#### **24.5 Contact data**

The relevant contacts for registration, certification, code attribution and change requests is given in Annex 23.

## **25 Glossary**

See Annex 24.

## 26 List of Appendices

### Messages

- **Annex 1 – Message Catalogue** (target TAP TD B.30 and TAF Annex D.2, Appendix F)

The Messages are in xsd. Note that rtf/document formats should only be looked at by xml/message experts and it is not recommended to be printed for all others. It is anyhow recommended to look at the specific messages in an xml-editor/viewer.

### Annexes to Part A

- **Annex 9.1 Data Model for Reference Files**

The Class diagram is used from the Central Repository Domain.

Within the functional data model (class diagram) the tables (classes) are described with their elements. The relations between the Tables are maintained. Elements are described by their Names and Type.

- **Update Message for Locations**

The XML schema shows the message to be used to update the CRD for locations by National Location File Entity or companies for Subsidiary locations for defined Subsidiary type code. → see xsd file in Annex 1, including this message

- **Annex 9.3 - HMI for Maintenance of Location**

The screen shows the draft User interface to update the CRD for update the locations by privileged users.

- **Annex 9.4 - Table of codes for Subsidiary locations (subsidiary type codes)**

- **Annex 9.5 - Code structure for initial population of and manual Bulk updates**

This structure can be used for those companies wishing to upload from existing databases (ENEE).

- **Annex 10 - Code lists**

Index of the code lists and suggested or existing responsible bodies for their maintenance. Code lists that have been identified as category C are essentially existing lists that are already maintained by an external responsible body.

The same xls-file contains the relevant codes.

### Annexes to Part B

- **Annex 12, Short Term Path Request Processes**
- **Annex 12.1 – Path Request Process diagrams**
- **Annex 12.2 – Elements specific to stakeholders**

- **Annex 12.3 – Message Examples**

It is not recommended to print this Annex unless the reader wants to read core xml. The messages in these annex can be looked at in any xml-Editor, that allows also to reduce the view to the necessary content.

The annex contains examples for the business scenarios of chapter 14 and one example for the Change of Track message (chapter 17).

## **Annexes to Part C Operations**

- **Annex 13**

The annex document covers all operational processes diagrams, containing the TAP and TAF process diagrams relevant for chapter 14 to chapter 21.

## **Annexes to Part D**

- **Annex 23 - Contact**
- **Annex 24 - Glossary**